

System 20



4500 Series Folding Door Installation Instructions

The record-usa 4500 slide/fold has been carefully designed, built, and tested to provide years of service. The life of the door package is directly related to how carefully the installation is accomplished and how accurately the instructions are followed. Installation of this door package is to be performed by properly trained and experienced installers knowledgeable with local code requirements and all requirements of ANSI A156.10 Standards for Power Operated Pedestrian Doors. The authorized service / installation dealer must perform all measurements for forces, speeds, and times to insure proper and safe operation. Verify that the door may be opened without power applied to the unit.

Verify that the force required to open the door with the power disconnected shall not be greater than 50 pounds.

Verify the door does not develop kinetic energy in excess of 7 foot-pounds.

Verify the door does not require a force greater than 30 pounds applied in either direction to prevent the door from closing.

record-usa is not responsible for improperly adjusted or maintained automatic doors or activation / safety systems and assumes no responsibility for damages caused by automatic door systems that have not been properly installed, tested, and adjusted.

NOTE: GLASS AND GLAZING ARE NOT INCLUDED IN THE PACKAGE.
THE GLAZING MATERIALS IN BOTH THE DOORS AND SIDELITES SHALL COMPLY WITH THE REQUIREMENTS IN THE AMERICAN NATIONAL STANDARD PERFORMANCE SPECIFICATIONS AND METHODS OF TEST FOR SAFETY GLAZING MATERIALS USED IN BUILDINGS, Z97.1.1975

OWNERS INFORMATION TO BE PROVIDED BY THE DISTRIBUTOR/INSTALLER TO THE OWNER

- * After the installation instruct the owner/supervisor on the safe operation of the door.
- * Location and proper use of the power switches.
- * Location of the main cutoff breaker.
- * Necessary warnings not covered in general instructions.
- * Owners Manual and Daily Safety Checklist.
- * Phone number(s) for the local servicing dealer.
- * What to do in the event that a dangerous situation should occur, and how to shut the doors down and call for service.

TABLE OF CONTENTS

OWNER INFORMATION / TABLE of CONTENTS.....	1
TOOL LIST / GENERAL REQUIREMENTS.....	2
FRAME , HEADER AND DOOR CONFIGURATION	3
SETUP, CALIBRATION AND LOCKING.....	4
DISPLAY PANEL CONTROL WIRING OPTIONS.....	5
COMMISSIONING THE 4500 USING DISPLAY CONTROL.....	6
PARAMETER ADJUSTMENTS.....	7
REMOTE CONTROL OF DOOR OPERATING MODE.....	8
SIGNAGE REQUIREMENTS.....	9
HEADER COMPONENTS.....	10
DOOR PANEL ASSEMBLY VIEW.....	11
DOOR PANEL ASSEMBLY LIST.....	12
HINGE PIVOT ASSEMBLIES.....	13
PARAMETER DESCRIPTIONS.....	14-22
WIRE DIAGRAMS - BEA SENSOR PACKAGE.....	23-24



4500 Series Folding Door Installation Instructions

TOOL LIST

- Knife
- 4' Level
- Hammer
- Chalk Line
- Wire Ties
- Wire Cutter
- Multi-Meter
- 4' or 6' Ladder
- Hammer Drill
- Tape Measure
- Electrical Tape
- Extension Cord
- 3/8" Cordless Drill
- Vise Grip Pliers
- Channel Lock Pliers
- Caulking & Gun
- Shim Materials
- Flat & Rat tail files
- Combination wrench set (standard & metric)
- Screwdrivers (#2 Small & #3 Medium Phillips)
- Allen Hex wrench set (standard & metric)
- Ratchet & Socket set (standard & metric)
- Drill bit set up to 3/8" & 1/4" & 5/16" masonry bits
- 7/16" Fine tooth Ratchet Wrench
- 25mm Open End Wrench

GENERAL REQUIREMENTS

- Power: 120VAC, 60Hz., 15 Amp Service to terminal block in aluminum head section of door. Wiring to be in conformance with local codes and routed away from moving parts.
- Non-North American voltages can be 230VAC, if so be sure the operator has a 230VAC power supply.
- Power may be brought in through the top of the jamb on perimeter mount units or in through the back of surface mount units.
- For remote switch locations, routing of low voltage wiring to the operator controls will be required and there locations should be predetermined and wired before installation begins.
- Door Panels may be glazed before or after installation.

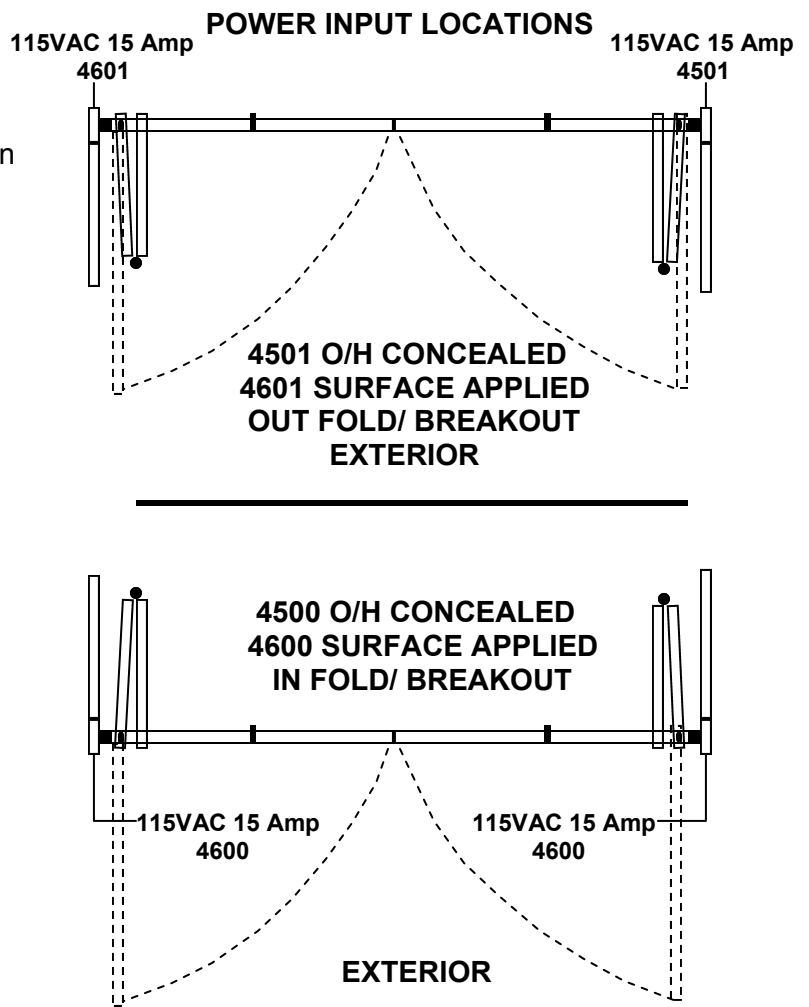



4500 Series Folding Door Installation Instructions

1. Verify rough opening dimensions are correct and square and floor is flat without high spots.
2. Attach jambs to Header with the 1/4-20 hex head bolts, lockwashers, and flat washers provided In the hardware pack using suggested 7/16" Ratchett wrench.. Attach safety beam harnesses and display control panel cable from jambs to Operator.
3. Install Header and jamb package in opening; shim as required to obtain level, plumb and square.
4. Use provided pivot template to locate and install floor mounted bottom pivots as seen to the right.
5. Snap jamb filler / fingerguard extrusion into jambs with offset towards exterior of unit.



NOTE: INSURE THE WEATHERPILE, CENTER OF FILLER/FINGERGUARD EXTRUSION LINES UP WITH CENTERLINE OF FLOOR PORTION, BOTTOM PIVOT.

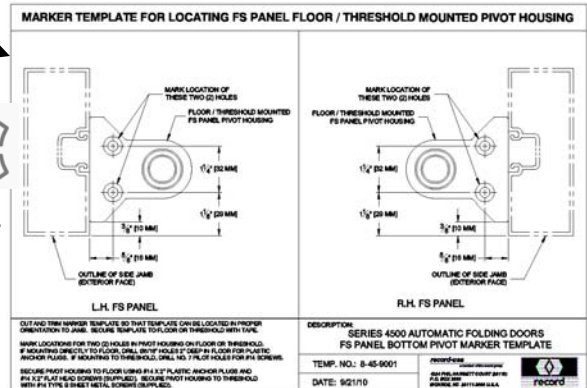

PIVOT TEMPLATE

6. Use operator belt to rotate top door arms to the door open position.
7. Remove nuts and bolts (2 each) from top door arm and panel endcap.
8. With Panel stood up in the open position, set onto floor pivot, then raise panel under door arm and reinstall hex head bolts into tapping plate. Loosen 3 bolts attaching door arms in top of door panel. Find correct set in the door closed position achieving the hard stop in the header and then retighten.
9. The Door panel should be tight up against the breakout member when it was fastened to the top arm. Use the operator belt to close panels and insure proper clearances. Loosen thin hex nut to lower door panel that it opens and closes without excessive drag against breakout member. (25mm)
10. After proper setting is achieved tighten hex locknut to the thin nut to maintain setting.
11. Proceed by insuring that bottom door pivot is seated to floor portion, then tighten the 2 Allen cap bolts in pivot stile.
12. Please see in picture at right, the adjustable hard stop indicated for the door open position.

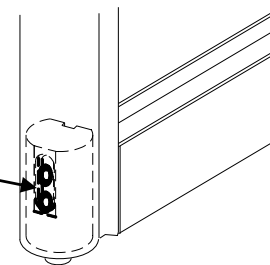
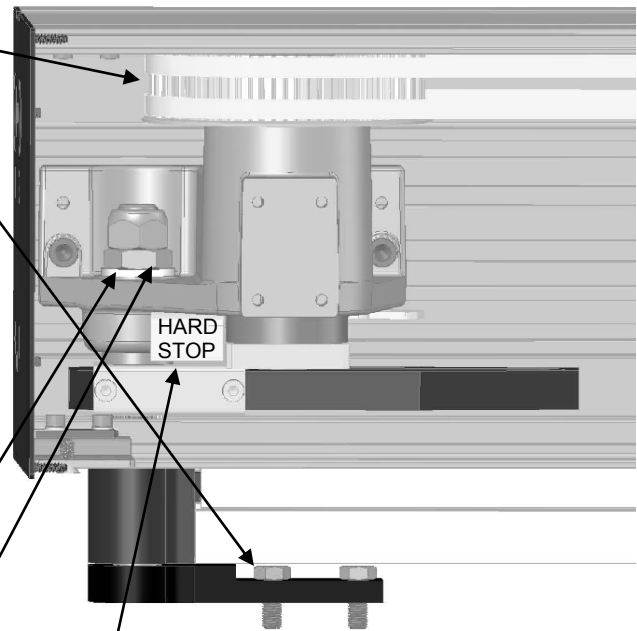



4500 Series Folding Door Installation Instructions

13. Please proceed with finding thin nut on top of silver arm that must be checked for being tight or loosened if and adjustment is required for fine tuning to achieve arm position. It is a bearing on an eccentric that can be turned for adjustment.

14. Remove 120VAC power cord from left hand end of power supply (refer to one of the attached wire diagrams in this booklet). Connect 120VAC Main Power to terminal block.

15. If onboard, connect standby battery to operator (disconnected for shipping). With doors in the open position, plug 120VAC power cord back into power supply. Unit should power up and close.

16. Proceed with the required Calibration run by Pressing and holding the blue button on the circuit board for three flashes; release, then momentarily press again to cycle the door. After the door closes, momentarily press again for a second drive cycle. This process can also be achieved with the FPC902 Programmer.

17. When a successful calibration has been achieved, proceed with the wiring of actuating and safety sensors, etc., per the attached wiring diagram.

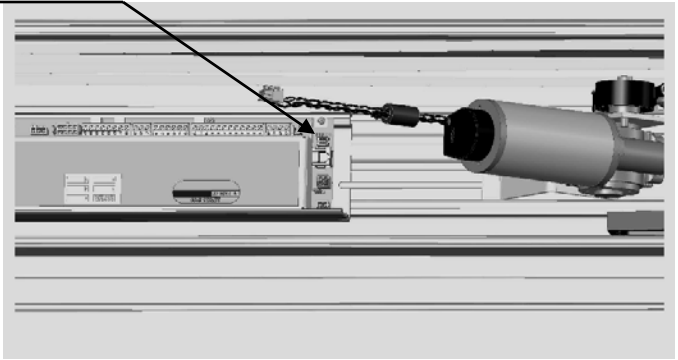
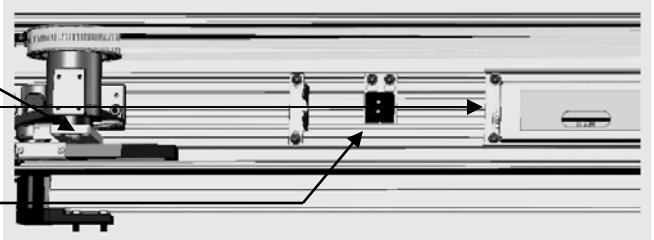

Locking:

The 4500 Slide/Fold has four electric lock options:

- No electric lock present;
- Belt Lock - to inhibit the fold;
- Breakout Lock - to inhibit the breakout function;
- Both locks - to secure both fold(Infold) and breakout functions.
- Panel Locks - to inhibit the fold (Outfold)

The belt lock, which inhibits the fold action, will be mounted on the left side (slave) drive pedestal on out-fold units, and to the right side (master) pedestal on infold doors. If this is the only electric lock, it is connected directly to the control. The Breakout Lock inhibits the breakout function and is mounted in the center of the header to secure both panels. When supplied alone, it also connects to the control. A monitored battery backup is included with the Breakout Lock to maintain operation during a power failure. When both lock types are installed, a Sequencing Control Module, 2xVRR20, is required. Typically located between the breakout lock and main control board, this module connects to the door control, and the two locks are connected to it. Two green LEDs on the module indicate +5VDC and +24VDC power is present.

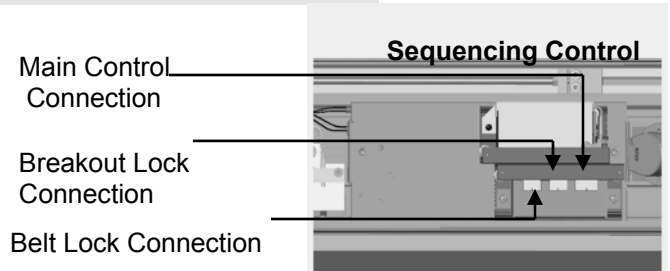
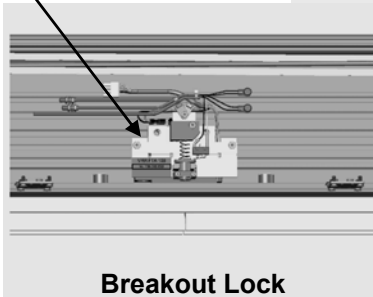
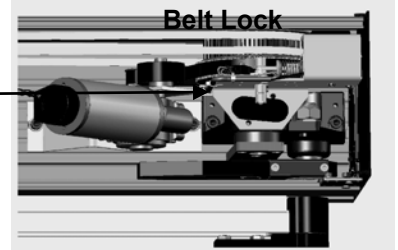



4500 Series Sliding Door Installation Instructions

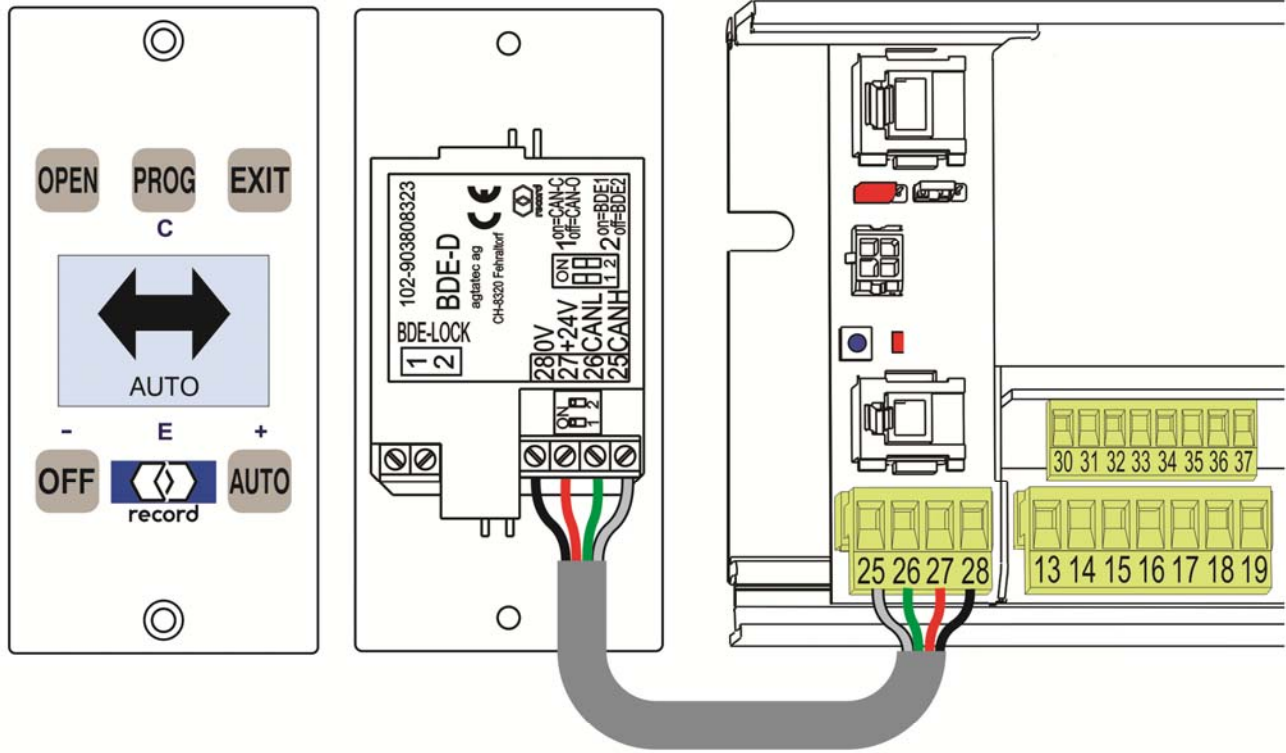

The Display Control Panel is connected to the Operator Control as shown and is typically mounted in or on one of the door jambs. The unit may be remotely mounted as desired, and should always be in a location where the user can view the door. A non-metallic white enclosure, mounting hardware, and 12 feet (3.6m) of wiring cable are included to mount the control panel as desired.

The keypad on the display can be disabled by removing the jumper located between screw terminals 1 and 2 on the back of the display (see above). A switch (SPST) can be wired in place of the jumper and provide remote enable/disable of the keypad.

When the keypad is disabled, a small key is displayed on the left of the screen. The unit will continue to display the current operating mode of the door and will exhibit any alarm condition as it occurs, but the keypad will not function.

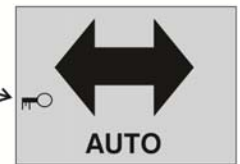

Two Display Control Panels can be connected to a Door Control for mode control from two separate locations. The panels are wired in parallel, and Dipswitch #2 (above wire terminals 26 & 27) on one panel should be set to "OFF". In addition to the Display Control Panel, two mechanical switch assemblies (shown at right) are available for connection to the door control. The mounting template is identical to the display panel. One of these panels can be used in place of the display on the door. Note: With both connected, the mechanical panel will have priority over the display panel when selecting operating modes. The display will indicate the mode selected by the mechanical panel.

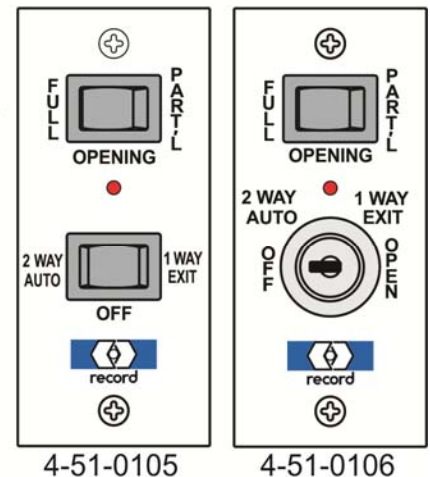



4500 Series Folding Door Installation Instructions

The Display Control Panel is a convenient input and output unit for the door system and programming of control units in record door openers. Logically arranged pushbuttons permit an intuitive operation of the door and navigation through the drive-specific menu structure. The backlit LCD display provides data and information regarding the status of the door using symbols and plain text messages. The connection to the door control is via the CAN bus built into the record products.

The technical specifications of the control panel are:

- Supply voltage: 24 VDC from CAN bus
- Connected load: < 2 W
- Dimensions: 1.74" X 3.63"
- Temperature range: 0°C to +50°C
- LCD display: 112 x 64 pixels (0.84" X 1.18"), with white backlight

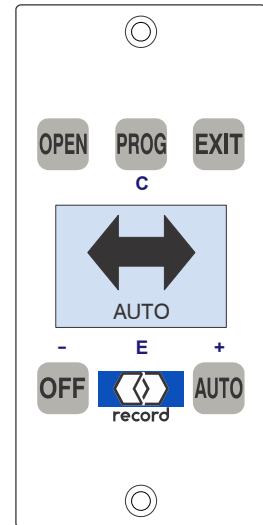

In addition to providing the owner a method for selecting the door operating modes, the control panel can be used to access and adjust the door parameters. To enable this feature, first gain access to the door operator in the header, and locate the microprocessor control. On the right side of the control is a small blue pushbutton (Control Switch Button), and a red LED. The pushbutton performs multiple functions depending upon how long it is pressed, as indicated by the adjacent red LED.

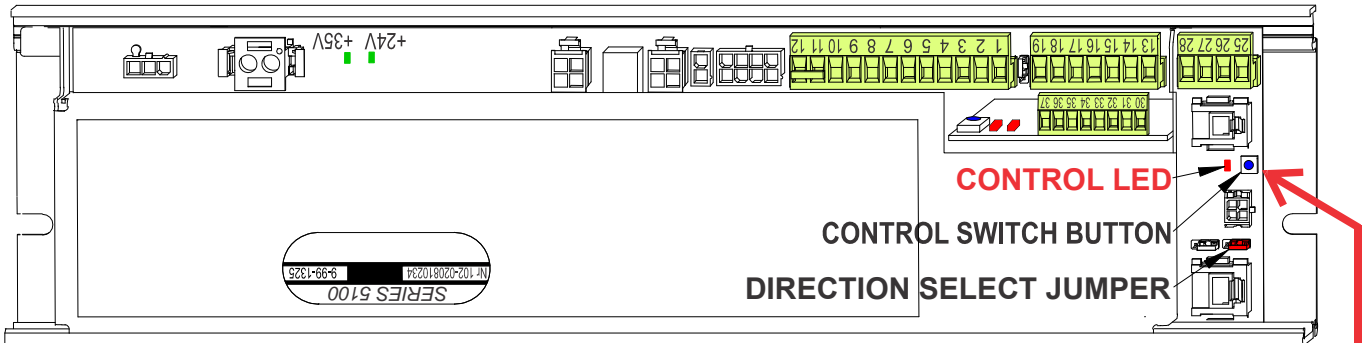

- Pressing and holding the button causes the adjacent red Control LED to pulse "on" approximately once per second. The number of pulses determines the resulting effect:
- 1 pulse simulates the actuation of the interior sensor and initiates a door cycle.
 - 2 pulses initiates an automatic acquisition of safety beam characteristics.
 - 3 pulses initiates a door learn mode where the door weight and friction are learned.
 - 4 pulses initiates a configuration mode where the Display Control Panel has access to the microprocessor control parameters.
 - 8 pulses resets the parameters to the default parameters for door type selected.
 - 9 pulses, combined with actuation of the breakout stop, will reset to factory settings.
 - 14+ pulses performs a hardware reset (no parameter values are changed).

Typically, during a new installation, the microprocessor will have already been set at the factory for the door opening, **but the completed installation will require a calibration mode initiated by holding the Control Switch Button down for three pulses of the Control LED. Calibration will occur during the next two door cycles, which should be initiated immediately.**



4500 Series Folding Door Installation Instructions

ALTERNATIVE CALIBRATION METHOD:

A convenient second method for calibration has been implemented using either the Display Control Panel or the FPC 902 Programmer. If using the FPC 902, select Service STG, select Yes to accept all parameters, press OK to Continue, then select Learning system. The next screens closely follow the screens described below. If using the Display Panel, press and hold the blue Control Switch Button for four flashes of the red Control LED, the release the button. The Display Control Panel should appear as shown at right. Use the AUTO button to scroll down and highlight "Learning system", then press the blue "record" logo.

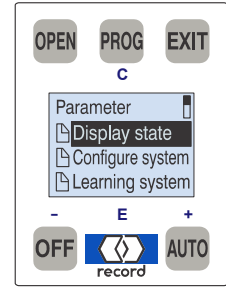

The screen at right will appear, press the "record" logo again, the door will open, with a screen indicating to wait until the door is completely open.

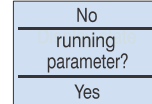

After the door fully opens, the screen will then display - Press and hold the "OFF" button until the door fully closes. Once closed, the door will re-open and this screen will appear again. Press the "OFF" button until the door closes, and the screen at right will appear. Press the "record" logo to continue.

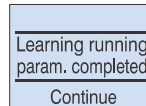
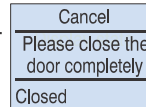

In response to the screen displaying "Learning sensors?", press the "PROG" button to decline. In response to the screen displaying "Learning suppression SIO?", press the "PROG" button to decline. The calibration cycle will then be completed.

PARAMETER ADJUSTMENTS:

The parameters that define the door performance can be accessed using either the FPC 902 Hand-Held Programmer or the Display Control Panel.

For access to all of the parameters with the FPC 902, Version 2.71 or later software is required

To access the control parameters using the Display Control Panel, on the door control press and hold the Control Switch for 4 flashes of the adjacent red Control LED.

In this mode, the top center "PROG" switch and bottom three switches are used to select and modify the door parameters.

- Note the small blue legends next to each switch indicates its use in the configuration mode -
- Use the "+" (AUTO) switch to scroll down menus, or increase individual parameter values.
- Use the "-" (OFF) switch to scroll up menus, or decrease parameter values.
- Use the "E" (record) switch to select the currently selected parameter or parameter value.
- Use the "C" (PROG) switch to revert to the previous screen.

Included in the header should be a two-sided sheet identifying the Control Parameters and the factory settings for that header. Any field changes should be noted as they are implements.

A complete listing of the parameters with descriptions is included with the Installation Instructions.

To exit the parameter adjust mode, press the "C" (PROG) multiple times until the "Exit Program Mode - Yes/No" screen appears; press the "E" record switch to return to Door Operating Mode screens.

Note: If no button os pressed for 3 minutes, the parameter adjust mode is automatically exited.

Entering a custom telephone number to be displayed when alarm screens occur can be performed only with the FPC 902 Programmer. Refer to the instructions included with it for further details.



4500 Series Folding Door Installation Instructions

SERIES 4500 - REMOTE CONTROL OF DOOR OPERATING MODE

Jan2013

The following describes several different methods of remotely controlling the door operating mode.

1. For complete remote control, install a second Display Control Panel at the remote control station. Changes to the operating mode will be displayed on both Display Control Panels. Locking the keypad on the panel at the door can be accomplished by two methods -

A. On the panel to be locked, press the keypad sequence  + **PROG** + **OFF**. A small square with an X will appear on the left of the display, and the keypad will no longer change the door operating mode. The display will update as changes are made remotely. To unlock the keypad, repeat the above sequence.

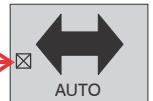

B. On the back of the Display Control Panel is a two conductor terminal block with a jumper. If the jumper is removed, the keypad will be locked and will be indicated by a small key on the left side of the display. The jumper can be replaced by a remote mounted switch (toggle, key, etc.).



2. To remotely lock the door, one of the three programmable inputs, AUX00_IN (Terminal 4), AUX01_IN (Term. 6), or AUX04_IN (Term. 18), can be programmed to lock the door with the "SURV" parameter. With SURV enabled, applying +24VDC from Terminals 5 or 19 will allow the Display Panel to set the door operating mode. Removing the +24V will change the operating mode to "Locked". If the door is open, it will close and lock, with Safety Beams active during closing. The Remote Switch / Special Activation input (Terminals 11 & 12) will unlock and open the door. After the time delay set by the parameter "Time Delay - Remote Switch", the door will close and re-lock.

Note: The programmable input with this parameter enabled cannot be used for other functions.

3. To remotely change the door operating mode to "1-Way" (Exit) mode, one of the three programmable inputs, AUX00_IN (Terminal 4), AUX01_IN (Term. 6), or AUX04_IN (Term. 18), can be programmed to set the operating mode "EXIT" with the "SURA" parameter. With SURA enabled, applying +24VDC from Terminals 5 or 19 will allow the Display Control Panel to set the door operating mode. Removing the +24V will change the operating mode to "EXIT". When the door is closed, the Exterior Sensor will be ignored. When the door is open, the Exterior Sensor will hold the door open, and will re-cycle a closing door back to the open position.

Note: The programmable input with this parameter enabled cannot be used for other functions.

The programmable inputs can also be used to enable other functions as described in the Parameter Explanation Section. For example, one of the programmable inputs can be set to override the Display Control Panel and the pedestrian Sensors, and either open or close the door. This is accomplished by enabling the "SÖK_NSK" parameter (Emergency Override), and setting the "Emergency Open / Close Function" to either open or close the door. If closing is selected, additional options are available to lock the door, and select what inputs are active.

Note: Priority between the above inputs and the Display Control Panel is set by safety / security rules. If either the remote control or the Display Panel is set to "OFF" (or Locked), the door will be off (locked) and the mode cannot be changed. If the remote control has set the operating mode to AUTO(matic), the Display Panel will have full functionality. If the remote control has set the operating mode to EXIT (1-Way), only the Display Panel's OFF button will function. If the remote control has set the operating mode to (Continuously) OPEN, only the Display Panel's OFF and EXIT buttons will function.



4500 Series Folding Door Installation Instructions

Daily Safety Check Decal
Adjacent to Control Panel

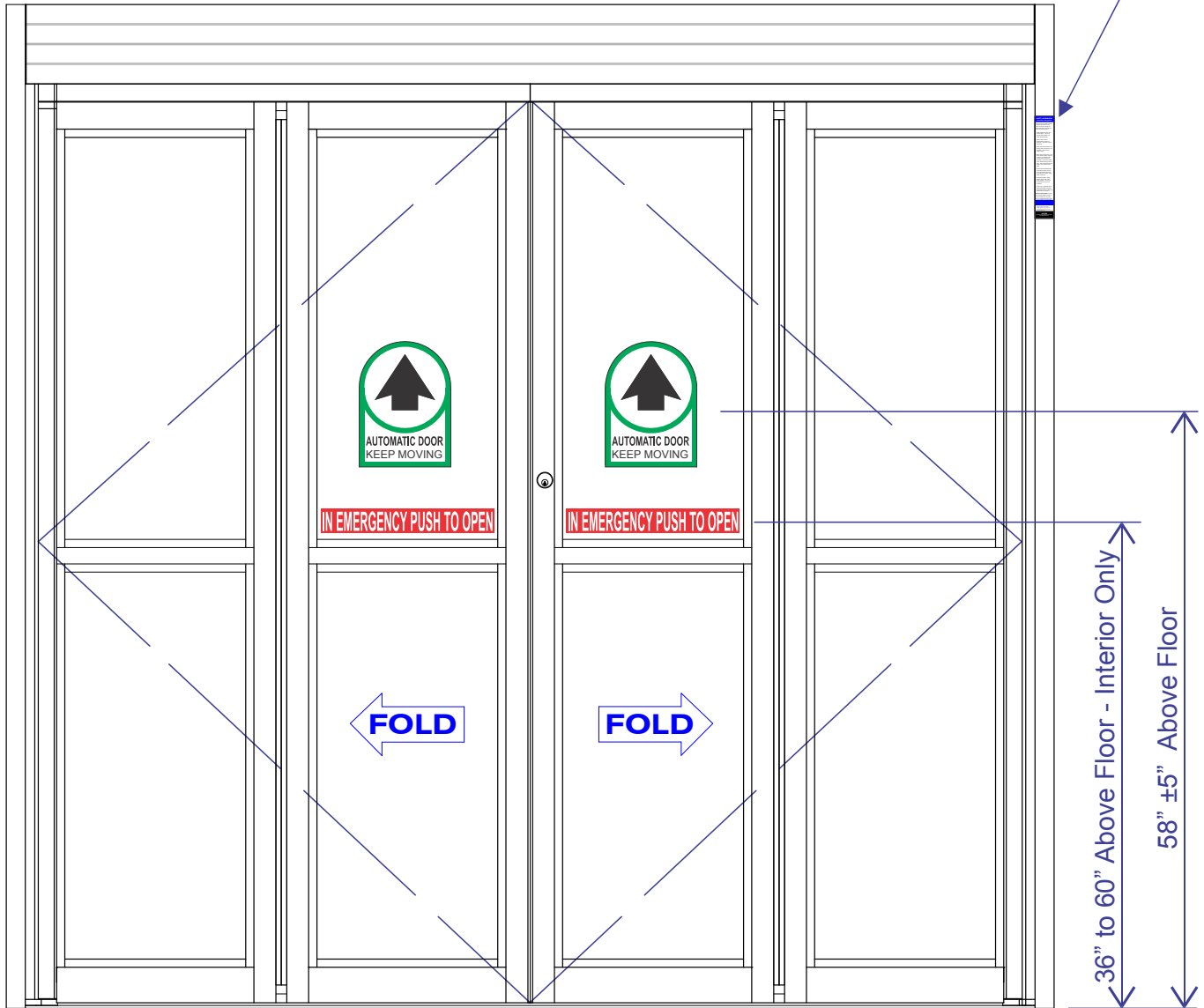

Decals shown above are for Non-Fold, Approach Side of Door

For Two-Way Traffic Doors, on the Fold Side, use



in place of



For One-Way Traffic Units, on the Non-Approach Side, use



in place of



For Knowing-Act Traffic, use



4500 Series Folding Door Installation Instructions

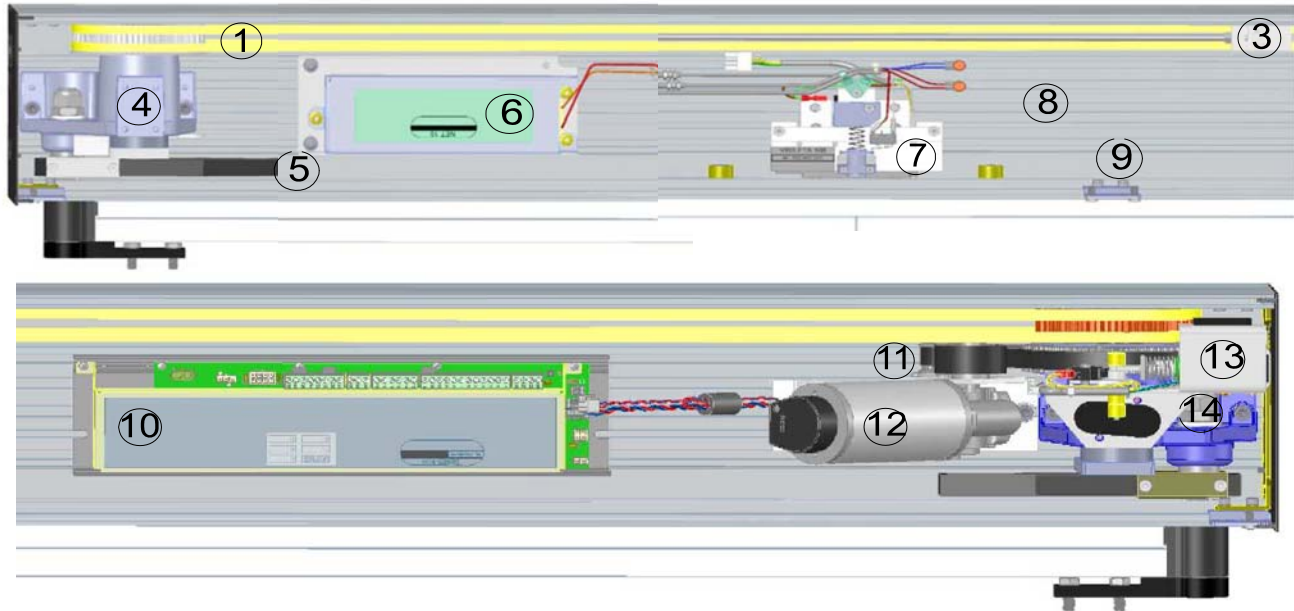

ITEM	PART NUMBER	DESCRIPTION	QTY.
1	9-09-0015	BELT, MAIN DRIVE	2
2a	9-45-0011	TIE ROD, BELT CLAMP, SHORT	1
2b	9-45-0013	TIE ROD, BELT CLAMP, LONG	1
3a	9-45-0010	BELT CLAMP, RIGHT	1
3b	9-45-0012	BELT CLAMP, LEFT	1
4	9-45-0101	DRIVE PEDESTAL, SLAVE	1
5	9-45-0103	INNER ARM ASSY.	2
6	4-45-0014	MODULE, POWER SUPPLY	1
7	9-45-0106	* ELECTRIC LOCK, ANTI-BREAKOUT	1
8	5-45-4001	HEADER EXTRUSION, FOLDER, CL-DB	~
	5-45-4002	COVER EXTRUSION,FOLDER HEADER,CL-DB	~
	4-45-1001	BRACKET, HEADER TO JAMB	2
	4-45-1002	END CAP, HEADER	2
9	4-45-1003	BRACKET, COVER ATTACHMENT	4
10	9-99-1325	CONTROL, System 20, S4500, 5100	1
11	9-09-0014	BELT, MOTORDRIVE ASSY.	1
12	9-45-0104	MOTORDRIVE ASSY.	1
13	9-45-0105	*ELECTRIC LOCK, DRIVE PEDESTAL	1
14	9-45-0102	DRIVE PEDESTAL, MASTER	1
* IF BOTH LOCKS ARE USED, THE FOLLOWING MODULES WILL BE REQUIRED FOR SEQUENCING			
15	9-45-0109	SEQUENCER, ELECTRIC LOCKS, System 20	1
16	4-51-0812	UNINTERRUPTIBLE POWER SUPPLY (UPS)	1

4500 SLIDE / FOLD FX/FS DOOR PANELS

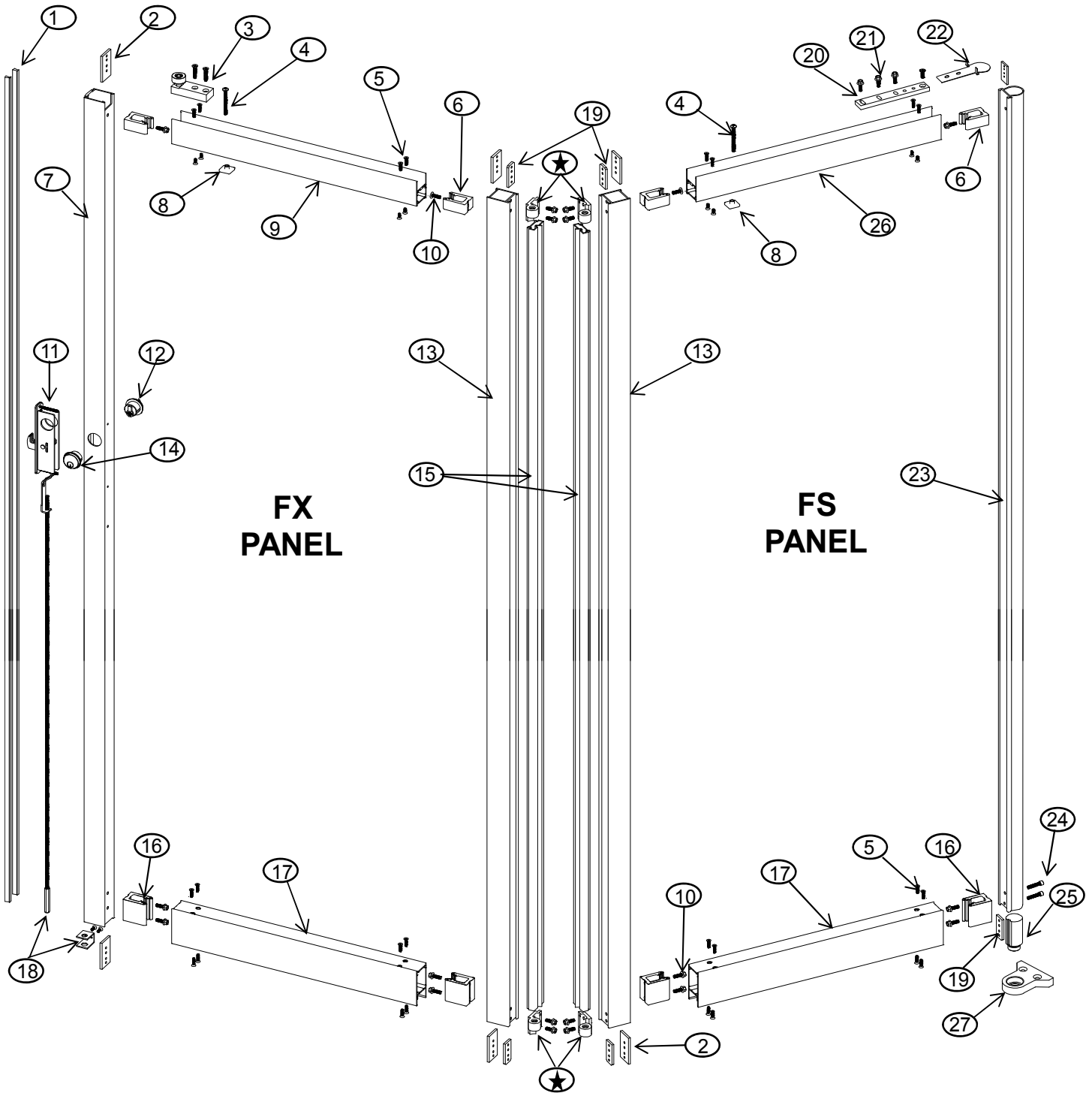



4500 Series Folding Door Installation Instructions

4500 SLIDE/FOLD DOOR PANEL PRICE LIST			
FX PANEL			
ITEM	PART NUMBER	DESCRIPTION	QTY.
~~	REPL-45-PANEL	FX PANEL ASSY.	1
1	9-99-7316	Weatherpile, Mohair, BL	~
2	4-11-1082	Plate, Backer	4typ
3	4-45-0016	Guide Roller Assy., Top	1
4	81-0014-0680	Screw, 1/4-20x2" PPH	1
5	81-4411-0516	Screw, 10-24x3/4"PFH	20typ
6	4-11-4096	Block, Shear, 2 1/2"	2
7	5-11-4021-CL	Stile, Tandem, Narrow, CL-DB	1
8	6-51-9006	Block, Glass Jacking	1
9	5-11-4032-CL	Rail, 2 1/2" , CL-DB	1
10	81-0017-3666	Screw, 1/4-20x3/4" HWHMS Gr8	6typ
11	9-99-0071-CL	Deadlock, Hookbolt	1
12	9-99-0069-CL	Cylinder, Thumbturn, CL-DB	1
13	5-45-4008-CL	Stile, Hinge, CL-DB	1
14	9-99-0064-CL	Cylinder, Key, CL-DB	1
15	4-45-9001	Seal, Hinge Stile	1
16	4-11-4097	Block, Shear, 3-31/2"	1
17	4-51-4190-CL	Rail, Bottom, FX & FS Panel	1ea.
18	9-99-0074	Threshold Bolt & Guide	1
19	4-45-1004	Plate, Backer, Pivot Stile & Hinge Pivots	6
★	See Next Page for Hinge Pivot Info		
FS PANEL			
~~	REPL-45-PANEL	FS PANEL ASSY.	1
20	4-45-4012	Spacer, Top Pivot Arm	1
21	81-0017-3666	Screw, 1/4-20x3/4" HWHMS Gr8	3
22	4-45-1006	Cap, Pivot Stile	1
23	5-45-4009-CL	Stile, Pivot, CL-DB, (FS Panel)	1
24	81-0016-2674	Screw, 1/4-20x1 1/4"	2
25	4-45-0015	Bottom Pivot Assy.	1
26	5-11-4032-CL	Rail, 2 1/2" , CL-DB	1
27	4-45-4011-BL	Base, Pivot Bearing, Floor Portion	

4500 SLIDE/FOLD HINGE PIVOT ASSEMBLIES

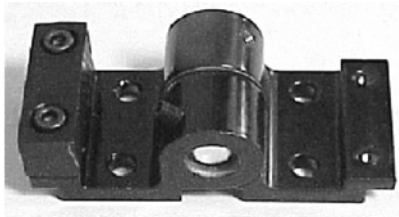
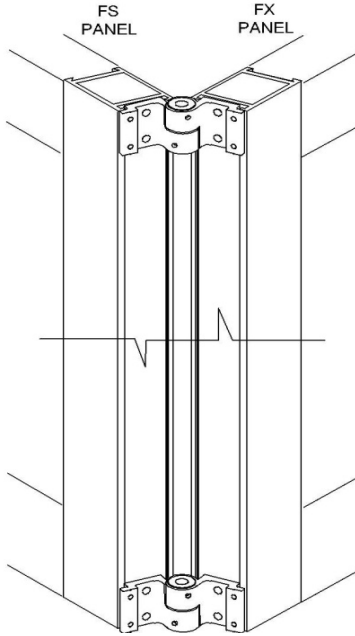

CONFIGURATION "A"

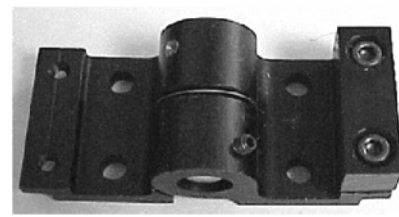
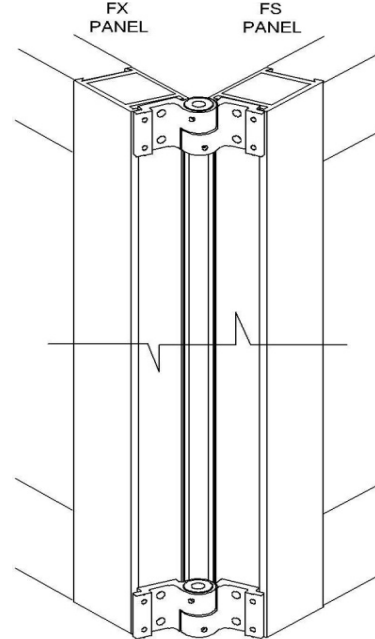

CONFIGURATION "B"

ITEM	PART NUMBER	DESCRIPTION	QTY.
1	4-45-0022-BL	FOLDER HINGE PIVOT ASSY.	1
		CONFIGURATION "A"	
		DUAL OUTFOLD - LH LEAF	
		DUAL INFOLD - RH LEAF	
2	4-45-0023-BL	FOLDER HINGE PIVOT ASSY.	1
		CONFIGURATION "B"	
		DUAL OUTFOLD - RH LEAF	
		DUAL INFOLD - LH LEAF	

PARAMETER Default Setting(X) Description

DRIVING CYCLE		
Closing speed	0... 20 ...40	Speed: 0 = slow (Creep speed), 40 = fast Note: Small doors may not reach the set speed, depending upon acceleration rate.
Opening speed	0... 36 ...40	Same as closing speed
Open		
Acceleration	0... 30 ...40	Acceleration: 0 = slow, 40 = rapid acceleration
Deceleration	0... 30 ...40	Braking momentum during opening cycle Deceleration: 0 = slow, 40 = rapid braking force
Creep section	0 ...40	Adjustable creep section at the end of the opening motion. Note: 0 = no creeping 1 = 2.5% of Door Opening Width (DOW) 40 = 100% of DOW
Close		
Acceleration	0... 30 ...40	Acceleration: 0 = slow, 40 = rapid acceleration
Deceleration	0... 30 ...40	Braking momentum during closing cycle Deceleration: 0 = slow, 40 = rapid braking force
Creep section	0 ...40	Adjustable creep section at the end of the opening motion. Note: 0 = no creeping 1 = 2.5% of Door Opening Width (DOW) 40 = 100% of DOW
Holding force	0... 20 ...40	Holding force in closed position Note: In case of high holding force the motor temperature will increase, and may reduce power available.
Ramp		
For doors that drop at full closed (type OP-door 2), a ramp can be configured at the full closed position. The ramp function is only enabled in the opening direction. Before the learning cycle, the door briefly stops after the ramp. Note: In the area of the ramp the obstruction monitoring is reduced!		
Section	0...40	Length of the ramp (at horizontal) i.e. with a bipart the total opening of the door leaves is twice as big. Note: 0 = ramp function disabled 1 = 4 cm horizontal length of ramp (increments = 0.2 cm) 40 = 12 cm horizontal length of the ramp
Force	0...40	Applied force in the area of the ramp Note: 0 = light force, produces a minor acceleration 40 = heavy force, produces a major acceleration
Seal	0...40	Width of the seal in the closing area. In the adjusted area the obstruction monitoring is reduced during the closing phase. During a learning cycle, increased force is used to attain the closed position. Note: 0 = no seal 1 = 10 mm seal width (in driving direction) 40 = 30 mm seal width (in driving direction)
TIME DELAY OPEN		
Time delay open	0 ...40 (Plant - 3)	Hold-open time when actuated by Interior / Exterior Sensors. Delay starts when actuating signal is removed 0 to 20 = increment 1 second (0 – 20 seconds) 21 to 40 = increment 2 seconds (22 – 60 seconds)
Time delay - Remote switch	0... 4 ...40	Hold-open time when actuated by Remote Switch or SSK. Delay starts when actuating signal is removed 0 to 20 = increment 1 second (0 – 20 seconds) 21 to 40 = increment 2 seconds (22 – 60 seconds)
SSK delay	0 ...40	Delay <u>before</u> opening when actuated by Remote Switch or SSK 0 to 40 = increment in 0.2 sec. (0 = 0 sec.; 40 = 8 sec.)

SERIES 4500 / 4600 PARAMETER DESCRIPTIONS

PARAMETER	Default Setting(X)	Description
Reset with button		
Disabled	X	
Enabled		
DRIVE		
Partial Opening	0...26...40	Reduced opening as energy-saving measure 0 = minimum opening = 4 inches per door leaf 40 = full Door Opening Width (DOW)
Close Obstruction	0...20...40	Threshold sensitivity to an obstruction during closing. The kinetic energy of the moving door is partially absorbed by the obstacle, until the control detects the increased force. 0 = gentle; 40 = significant
Open Obstruction	0...20...40	Threshold sensitivity to an obstruction during opening. The kinetic energy of the moving door is partially absorbed by the obstacle, until the control detects the increased force. 0 = gentle; 40 = significant
Brake		Controls optional internal brake installed in encoder housing
Without	X	Either motor is without brake or brake is not used.
Closed position		Brake energized in closed position, including mode "Locked".
Open position		Is braked in open position in operating mode "Continuously open" as well as with "Reduced opening" and actuation by SSK.
Closed/One-Way/Locked		Brake energized in closed position when in modes "One-Way / Exit Only" and "Locked".
Closed, Locked		Brake energized in closed position when in mode "Locked".
Motor		Based on the control used, not all motor drives are supported.
Without	X	
ATE 20		Motor is automatically identified Designation: ATE STA 20 (size 63x55)
ATE 21		Motor is automatically identified Designation: ATE STA 21 (size 63x25)
ATE 19 small		Designation: ATE STA 19 (size 63x25) NOTE: ATE 19 is not detected automatically.
ATE 19 large		Designation: ATE 19 (size 63x55) NOTE: ATE 19 is not detected automatically
ATE 16 normal		Designation: ATE 16 (102-016029001) NOTE: ATE 16 is not detected automatically
ATE 16 heavy		Designation: ATE 16 (102-016025001) NOTE: ATE 16 is not detected automatically
ATE 17		Designation ATE 17 (size 63x25) NOTE: ATE 17 is not detected automatically
ATE 20 Folding door	(Plant - ✓)	ATE 20 with special pulley for folder (ATE 20 will be detected automatically and set for door type Folder)
ATE 16 Folding door		ATE 16 with special pulley for folder NOTE: ATE 16 is not detected automatically
ATE 16 30V		NOTE: ATE 16 is not detected automatically
ATE 20 / 200		Motor is automatically identified
Two motors		
Disabled	X	
Enabled		
Emergency operating BAT		Configured action is carried out with lead-acid battery when either - the unit experiences loss of incoming power; or the battery voltage is low. Note: Once action is completed, the control powers down In the powered down state, the control will respond to a SSK actuation, and the door will open with battery power.
Close, do not lock		Door closes, but does not lock
Unlock and open		Door unlocks and opens
Close and lock		Door closes and locks
Open if not locked	X	Door opens, as long as it is not in mode "Locked"

SERIES 4500 / 4600 PARAMETER DESCRIPTIONS

PARAMETER	Default Setting(X)	Description
Power failure		
Battery operation		Door continues normal functioning until battery capacity is low, then the configured Emergency operating BAT function is executed.
Emergency operation	X	After a power failure, the door immediately performs the operation specified by "Emergency operating BAT".
Battery		
Without battery	X	
Lead-acid battery		Battery is automatically identified on application of incoming power.
ENTRANCE SYSTEM		
A-dimension	650 ... 2000	Door Opening Width (DOW) - measured in mm: 0 to 59,999
G-dimension		Door Opening Height (DOH) - measured in mm: 0 to 59,999
Door leaf		Supports calculation of door parameters
DST		Bi-parting door D-STA, D-TSA
EST-L/R		Single-leaf door left / right: E-STA, E-TSA
Interlock(with FEM-1)		Requires a FEM-1. Direction detecting sensors are recommended to avoid nuisance open cycles (depending on the operating mode). A SIS-signal during the closing cycle affects only the open door. The reduced opening width is supported.
Disabled	X	
All operating modes		Interlock is active during operating modes: Automatic, One-way, & Locked. The interlock function is ignored if both doors are in the operating mode "Continuously Open". This operating mode is to be used for the passage of bulky goods. Manual control of the door is not recommended, because it's only possible to open the opposite door, if the door is pushed closed completely in manual mode. A locked outer door will be unlocked and opened by an interlocked control unit receiving a SSK actuation.
One-way & Locked		Interlock is active during operating modes: One-way and Locked. During the automatic mode both doors open at the same time, as soon as activation has taken place on one side. The operating modes Manual and Continuously open are described under the above "All operating modes".
Door type		NOTICE: A modification of door type causes a reset of the running parameters and sets certain parameters, such as AUX0-IN, to a predefined function. Some drives only support certain door types.
Basic operator	X	European standard operating mode
CO48 Ventouse		Mechanical power storage, with separate carriage, which is maintained in closed position by a magnet.
TOS		Surveillance of manual locking devices on the door leaves. Inputs must be programmed on FEM-0: TOS_DV1, TOS_DV2. Operating mode "Automatic" or "One-Way": manual locking device(s) must be open (0V/open on AUX2_IN and AUX3_IN), otherwise door fails to open Operating mode "Locked": manual locking devices must be closed, otherwise anti-burglar protection is not guaranteed. error 29 on Display Control Panel. SSK function is enabled.
FlipFlow		The bi-parting swing door (DDF) has been successfully integrated. For the FlipFlow the adjustable speed for the safety signals (Emergency Open or Close) has been created. Note: In case of Emergency Open or Close operation, safety inputs are ignored An increase in speed reduces the personal safety, but increases the building security.
CO48 Sandow Direct		Mechanical power storage for door motion during a power failure, or emergency condition.

SERIES 4500 / 4600 PARAMETER DESCRIPTIONS

PARAMETER	Default Setting(X)	Description
Basic escape route		Standard requirement for the UK, always with lead - acid battery Power failure response: Reaction according to "Emergency operating BAT". After return of mains voltage, the previous operating mode is restored. Battery problem response: In case of a defective or insufficiently charged battery, the door opens approximately 12 inches and stops; This can be reset by momentarily removing power, or using the FPC 902, or momentarily interrupting the Emergency Stop input.
Folding Door, Austria		Operation compliant with regulations in Austria
Breakout USA		When enabled, the following parameters are modified: Emergency stop with reset cannot be enabled; Sidescreen sensing (SIO) is set to creep.
Ratchet		Function for pulse control (Safety active) AUX00_IN (Terminal 4) is actuated by application of +24VDC Door closed: when actuated, door opens and remains open If actuated when door is closed, door will open and remain open If actuated when door is open, door will close and remain closed If actuated when door is opening, door will stop; a 2nd actuation will cause the door to open If actuated when door is closing, door will return to open and stop A door in Locked Mode will not respond to AUX00_IN To unlock and open the door, the SSK input has to be actuated and remain actuated (dead man OPEN). After reaching the closed position, (AUX00_IN) will lock the door again. The operation mode Continuously open will open the door Emergency Override (Open or Close) cannot be enabled.
Dead man		Dead man - doors actuated by "Knowing Act" devices, and require continuous actuation during door motion. Door will stop if signal is removed, and will resume when signal resumes. AUX00_IN (Term. 4) = Opening Input; +24V will initiate opening AUX01_IN (Term. 6) = Closing Input; +24V will initiate closing If both inputs are actuated simultaneously, door will stop, and both signals must be removed before door will respond to a subsequent signal. A door in Locked Mode will not respond to AUX00_IN To unlock and open the door, the SSK input has to be actuated and remain actuated (dead man OPEN). After reaching the closed position, (AUX01_IN) will re-lock the door.
OP door 1		Preset Parameters: Open and Closed Creep sections are set to 4 Time Delay Open and Time Delay Remote Sw. are increased AUX00_IN = AKA pushbutton AUX01_IN = Continuously open Push to actuate is enabled
OP door 2		Same configuration / pre-settings as OP door 1. In addition, the ramp (value = 20) and the seal (value = 20) are enabled.
Folding door USA	(Plant - ✓)	Door size cannot be determined by standard methodology (rotary motion of the drive does not vary with door size). For optimal door operation (including Obstruction detection), the Door Opening Width (DOW) should be keyed into the "A-dimension" above, using either the FPC 902 or the Display Control Panel
Smoke-protection	Not Available	

SERIES 4500 / 4600 PARAMETER DESCRIPTIONS

PARAMETER	Default Setting(X)	Description
3 button		Requires FEM 0 Expansion Module Functions: OPEN – CLOSE – STOP AUX00_IN (Term. 4) = Open Input; +24V will initiate opening AUX01_IN (Term. 6) = Close Input; +24V will initiate closing, signal must be maintained during closing or door will stop. AUX02_IN (FEM 0) = Stop Switch (SIO), both opening & closing A door in Locked Mode will not respond to AUX00_IN To unlock and open the door, the SSK input has to be actuated and remain actuated (dead man OPEN). After reaching the closed position, (AUX01_IN) will lock the door again. The operation mode Continuously open will open the door.
Default		
Folding door, basic		Similar to "Folding door" above; optimized for Europe.
Industry 1		
CONTROL PANEL		
Mechanical Panel		Connect to AUX00_IN and AUX01_IN or with FEM-0
Disabled	X	
3 Pos. (AUTO)		Will require programming of parameters in Input/Output / STG: AUX00_IN = BDEM2 and AUX01_IN = BDEM1
One-way (EXIT)		Will require programming of parameters in Input/Output / STG: AUX00_IN = BDEM2 and AUX01_IN = BDEM1
Rocker & KeySw		Will require programming of parameters in Input/Output / STG: AUX00_IN = BDEM2 and AUX01_IN = BDEM1
Partial Opening		Will require programming of parameters in Input/Output / STG: AUX00_IN = BDEM2 and AUX01_IN = BDEM1
Display Panel		Note: After changing Display Panel settings, it is recommended to initiate a soft reset of the control to insure new settings are saved.
Language	(Plant - Eng. US)	Language is selected when first starting the Display Control Panel (and after resetting factory settings): Deutsch/Francais/English/ English US , Italiano, Espanol, Nederlands, Danish, Slovenscina, Polski, Magyar, Czech
Keyboard	Locked (Plant - OFF)	Locked-mode: If not closed, when selected, the door will close. If unit has electric lock, it will be engaged; if no lock, the motor will power the door closed when a manual open motion is attempted. OFF-mode: Unit will stop automatic operation and will not resist manual motion of the door.
Contrast BDE 1	0... 20 ...40	Display contrast for Primary Display Control Panel Note: 0 = lower contrast (hardly noticeable) 40 = higher contrast (possible streaking on display)
Contrast BDE 2	0... 20 ...40	Contrast for Second Display Panel (Similar to Contrast BDE 1)
Brightness BDE1	0... 20 ...40	Display brightness (backlight) for BDE 1 Note: 0 = pale backlight for applications with weak ambient light 20 = medium backlight for normal ambient light conditions 40 = intense backlight for applications with bright ambient light
Brightness BDE2	0... 20 ...40	Display brightness (backlight) for BDE 2 (similar to BDE 1)
Light time delay	0... 10 ...40	Period of time for backlight illumination of display 0 = no lighting 1 - 39 = lighting period in seconds 40 = backlight illumination constantly on
Default operating mode		This designates the operating mode if no BDE-D or FEM-0 is connected or are interrupted, and if no BDE-M outputs are configured.
Off	(Plant - ✓)	
Locked	X	

SERIES 4500 / 4600 PARAMETER DESCRIPTIONS

PARAMETER	Default Setting(X)	Description
Automatic		Note: A locked door may change to "Automatic" operating mode if the Display Control Panel is disconnected or damaged. If this mode is requested by the owner, this should be discussed.
Continuous open		
LOCKING		
Locking function		Door is locked through selection of operating modes
Night locked	X	Electric lock is engaged when "Locked" operating mode is selected.
1-Way locked		Electric lock is engaged in 1-Way (EXIT) operating mode.
Always locked		Electric lock is engaged in all operating modes when door is closed.
Locking type		Locking types are not automatically identified & must be programmed
Without	X	No electric lock present
Motor-powered		VRR 20 (motorised, bi-stable)
Bi-stable		VRR 16 (magnetic, bi-stable)
MPV 20		Multipoint locking device, system 20 (motorised)
MPV 16		Multipoint locking device, system 16 (motorised)
Magnet (stand alone panel locks)		Magnet locking device (without VAK) unlocked with no voltage
Fail secure		Monostable locking device, locks with no voltage applied
Fail safe		Monostable locking device, unlocks with no voltage applied
Double		Triggering of the additional unit for 2 locks is used on FBO & PST
Start delay	0...40	Delay: max. 8 seconds between unlocking and door to begin opening
Closed VRR error		If enabled, a lock failure at closed will not cause the door to open 6".
Push force	0...40	Increases the closing force for a short time while locking and unlocking, in order to relieve mechanically the locking bolt.
CAN BUS		
Optional Units on CAN bus		Any unit connected is automatically identified & displayed with a "1". Disconnected units are displayed with "?" and must be removed manually with FPC902. Not available units are displayed with a "0".
FEM-0	0	Extended function module 0 <ul style="list-style-type: none"> - 2 configurable inputs - 1 configurable relay output (contact . 24V) - 2 ELS (Safety Beam) connections (pre-configured) - each 1 AKI-/AKA-connection (pre-configured) - BDE-M connection (pre-configured)
FEM-1	0	Extended function module 1 <ul style="list-style-type: none"> - 4 configurable inputs - 14 configurable relay outputs potential-free closed-circuit contact or break contact to be chosen Basic setting: closed-circuit contact - selection with jumper All FEM1 outputs can be activated with the available configurations Availability depends on control unit.
AKI 1	0	RAD: motion sensor 1 – interior
SI 1	0	RIC: safety sensor 1 – interior
AKA 1	0	RAD: motion sensor 1 – exterior
SA 1	0	RIC: safety sensor 1 – exterior
SL	0	AIR: safety "sidescreen" – left
SR	0	AIR: safety "sidescreen" – right
AKI 2	0	RAD: motion sensor 2 – interior
SI 2	0	RIC: safety sensor 2 – interior
AKA 2	0	RAD: motion sensor 2 – exterior
SA 2	0	RIC: safety sensor 2 – exterior

SERIES 4500 / 4600 PARAMETER DESCRIPTIONS

PARAMETER	Default Setting(X)	Description
INPUT/OUTPUT		
STG		
AUX00_IN AUX01_IN AUX04_IN		Terminals 4, 6, & 18 on control module STG 20 UNI Note: With parameters identified as " <u>Safety</u> " require a closed circuit for normal door operation, and when the circuit is opened the signal is enabled. Not all functions are available on each AUX input.
Disabled	X	
SÖK or NSK (Emergency Open or Close)		<u>Safety</u> opening or closing has priority over Actuating and Safety Inputs, and Obstruction Detection is ignored. Connection to +24V enables standard door operation. Interruption of the +24V to the input will initiate the programmed Emergency Open or Close.
SURV (Remote en- gagement of Locked mode)		System response to Input: 0V/open = "Locked" operating mode 24V = Operating mode set by Display Control Panel When used to "Lock", Display Control Panel cannot override Remote Sw (SSK) and safety beams remain functional.
BDE-M (Mechanical Control Panel)		AUX00_IN = BDEM_2 and AUX01_IN = BDEM_1, or connect to FEM-0 (preconfigured connections) Note: Mech. Panel must be enabled in Control Panel parameters Only one Mech. Panel can be connected When set to "Continuous Open", door opens, then changes to Manual mode. If Display Control Panel is also connected, the Mech. Panel has priority, except for "Off/Locked" mode, and Display Panel will indicate mode set by Mech. Panel.
Continuously Open		<u>Safety</u> input (+24V for normal door operation), Momentary signal: 1st pulse = Continuous open, 2nd pulse = previous operating mode Note: A locked door can be unlocked, safety sensors are active
SIS		<u>Safety</u> during closing cycle (Not active when door closed). Door will reopen and remain open when signal is open. 0V = actuated.
SIO		<u>Safety</u> during opening cycle, including inhibiting motion at beginning of open cycle. Not active during closing cycle. Will stop door or continue opening slowly (creep), based on parameter Input/Output / SIO below. Functional on all open actuators. 0V = actuated.
AKI Button reduced		Momentary actuation for reduced opening. Opening signal from other inputs will override and door will fully open. 24V = actuated. Will not open a door in "Locked" operating mode. Note: A maintained actuation of this input will not hold door open.
Broken rubber cord		
Opening Deadman		Maintained contact. When signal is present, door will open, if signal is removed, door will stop. Functional with Door Type: Dead Man.
Closing Deadman		Maintained contact. When signal is present, door will close, if signal is removed, door will stop. Functional with Door Type: Dead Man.
AKI Button		Momentary actuation for full door opening. 24V = actuated. Note: A maintained actuation of this input will not hold door open.
Closing Button		Momentary contact. When actuated, door will close. SIS is active. If door stopped or re-opened during closing (SIS), a 2nd contact closure will be required. 24V = actuated.
Ratchet		Sequential control (momentary actuation). See Door Type / Ratchet
Emergency Opening		<u>Safety</u> input. Door will open if not on "Locked" operating mode. Door will then revert to current operating mode. 0V = actuated.
SURA (Remote en- gagement of 1-Way mode)		System response to Input: 0V/open = "1-Way"(EXIT) operating mode 24V = Operating mode set by Display Control Panel When used to enable "1-Way / EXIT" mode, Display Control Panel can override only to "Locked / Off" operating mode. Remote Sw (SSK) and safety beams remain functional.

SERIES 4500 / 4600 PARAMETER DESCRIPTIONS

PARAMETER	Default Setting(X)	Description
AKA Button		Momentary actuation for full door opening. 24V = actuated. Not active when door in "1-Way / EXIT" operating mode. Note: A maintained actuation of this input will not hold door open.
AKA Button Reduced		Momentary actuation for reduced opening. Opening signal from other inputs will override and door will fully open. 24V = actuated. Will not open a door in "1-Way/EXIT" or "Locked" operating modes. Note: A maintained actuation of this input will not hold door open.
VRR manual		<u>Safety</u> input - used with lock monitor switch on mechanical lock not controlled by door controller. When actuated, Display Control Panel will alternately indicate "Manually Locked" and current operating mode. 4 second delay before return to set mode. 0V = actuated.
Reset SÖK_NSK		Reset Emergency Open / Close (Not available on AUX4_IN)
SIA	AUX04_IN: (Plant - ✓)	<u>Safety</u> input - typically used on folding door systems. If actuated when door is closed, door will either not open (stop) or open slowly (creep) based on Input/Output / SIA parameter below. If actuated when door open, door remains open until signal removed. SIA is ignored when door is in motion (open & close). 0V = actuated.
AUX0_OUT		Dry Contacts on STG: Terminals 8 (NO), 9 (COM), & 10 (NC) Rated 1 Amp at 30VDC
Disabled	X	
Test Sensors	Available only on CanBus Sensors	Is needed as functional test for safety sensors, and triggers prior to each "dangerous" door motion (e.g. closing motion)
Alarm output		After the configured time (parameter Miscellaneous / Alarm display) has expired, the error is displayed on the BDE-D and relay is de-energized. In normal mode, relay energized, COM & NO connected.
Gong		No ELS signal (Safety during closing/SIS): Relay is de-energized. Reacts to ELS or presence surveillance signal, when door is open/activated. In case of a constant signal, every 10 seconds a pulse will be activated for approx. 1 sec. This is applicable as well during the learning phase of a RIC 290.
Locked		When not locked: Relay is de-energized, COM & NC connected.
Closed		Output triggers slightly delayed, as soon as the door is closed (static opening D-STA < 20mm). Functional in Manual mode.
Warning		Pre-warning before the door opens/closes and while the door is in motion
Open	(Plant - ✓)	Relay energized when door is at full open (COM & NO connected), and remains energized until door begins closing.
AKI		Output triggers when Interior sensor is actuated.
AKA		Output triggers when Exterior sensor is actuated.
ZLP		
ZLP1		Additional printed circuit board to connect conventional threshold safety beams. Once the ZLP-ELS beams are recognized (automatic recognition), parameter can only be changed with the FPC 902.
Without	X	No additional printed circuit board connected
ELS	(Plant - ✓)	Additional printed circuit board connected for 2 ELS
FEM 0		See additional instructions provided with FEM 0 expansion module
FEM 1		See additional instructions provided with FEM 1 expansion module
Ext. Sw IN		Function of Exterior Sensor (AKA)
Ext. Sw IN		Exterior sensor is active during closing cycle when in operating modes "One-Way" and "Locked" for safety.
Inactive by 1way and locked		Exterior sensor is not active during closing cycle when in operating modes "One-Way" and "Locked".
Disabled		Exterior sensor is not active as a motion sensor; signals from it are ignored by the control unit. Presence detection with RIC 290 is possible.

SERIES 4500 / 4600 PARAMETER DESCRIPTIONS

PARAMETER	Default Setting(X)	Description
Emerg. Opn / CIs		Set functions of Emergency Signal Input
Function		Function Options: Disabled Emergency Open Emergency Close; Manual & Remote Switch active Emergency Close & Lock Emergency Close & Lock; Remote Switch active Emergency Close; Manual Override
Speed (Flip-Flow)	0...40	Set response time: 0 to 40. Applicable to Door Type Flip Flow only.
Emerg. Stop Reset		Disabled or Enabled
SIO		Function of Sensor covering Side Approach
Function SIO		Stop or Creep
Activate SIO	0...40	Adjustable 0 to 40
Suppression SIO	0...40	Adjustable 0 to 40
SIS		Function of Sensor covering door path: Stop Reversing direction Creep (Slow speed)
SIA		Function of Sensor for Folding Door Safety: Stop Creep (Slow speed)
MISCELLANEOUS		
TOWA		
Disabled or Enabled	X	If both Interior and Exterior Sensors are simultaneously actuated, or one actuated longer than 20 seconds, a door in "Partial Open" will fully open for that cycle, then revert back to "Partial Open" mode.
Push to act. Open		Note: Adjustment of holding force when closing is ignored
Disabled	X	
Normal		Opening width per current operating mode (Full or Partial Opening)
Reduced		Partial opening width
Push to act. Close		
Disabled Enabled		Note: Open time delay will be ignored if enabled and door is pushed.
Push Holding force	0...40	Force required to initiate function: 0 = light; 40 = heavy
Lead Time Open	0...1...40	Pre-warning time after the open signal, before the door actually moves, and warning continues while the door is in motion. Note: 0 = No pre-warning and no warning while in motion 1 = 0.2 seconds pre-warning + warning 40 = 8 seconds pre-warning + warning (opening delayed 8 sec.) The push to open function will interrupt the pre-warning delay.
Lead Time Close	0...1...40	Pre-warning after the open time expires, before the door begins closing, and warning continues during the door is in motion. Note: 0 = No pre-warning and no warning while in motion 1 = 0.2 seconds pre-warning + warning 40 = 8 seconds pre-warning + warning (closing delayed 8 sec.) The push to close function will interrupt the pre-warning delay.
Alarm display		Display for AKI/AKA/SSK or SIO/SIS/ELS If the alarm output is configured, it will be disabled after the preset time.
Time release	0...18...40	Delay time during a permanently "on" signal, until an error message is displayed - 0 = No Alarm Screens will be displayed; 1 to 40 = Delay before Display in 5 sec. increments (5s. min/200s. max)
Time safety	0...16...40	Similar to Time release above
Obstruction Alarm		
Disabled	X	The Display Control Panel will not indicate an Obstruction alarm.
Enabled		The Display Control Panel will indicate an Obstruction alarm. If the Alarm Output is configured (Input/Output / STG / AUX0_OUT / Alarm Display), it will also change state to indicate the alarm.

ALARM CODES AND ERROR MESSAGES

No.	Display text	Type	Res	Comments and possible troubleshooting
3	AKI > 60 sec. active			Inside radar longer than 60 sec. active and door remains open. Check that no moving objects are activating the radar.
5	AKA > 60 sec. active			Outside radar longer than 60 sec. active and door remains open. Check that no moving objects are activating the radar.
6	Unlocking error		X	Unlocking error: it is impossible to unlock the door. Repeat unlocking attempt after changing the BDE operating mode.
7	No redundancy test	RED	X	When no „redundancy“ test could happen within the last 24 h or the „redundancy“ test was not correctly performed on a door not locked. Reset. Control settings.
9	Battery fuse open		X	Battery fuse is disconnected or battery is not plugged in.
9	Open. unsuccessful			Door does not open or only slowly. SIO might possibly be active or motion be mechanically hindered (e.g. dirt in floor track).
10	Locking error			Locking error and door remains approx. 10 cm open → depending on parameterising door remains closed. Door might possibly be hindered or locking device might need to be adjusted.
11	Difference AKI	RED	X	Error in the interpretation of the inside radar signal. Check inside radar.
12	Low BAT voltage		X	Battery is missing or is not plugged in. Door works if mains voltage is provided.
12	BAT capacity		X	Battery no longer meets minimum power requirements. Replace Battery.
14	VAK defective		X	Locking device hampered. Adjust door leaves and locking device.
15	EMERG. OPEN.	RED		On RED installations emergency opening switch has been actuated.
17	Timeout open. time	RED	X	80% of escape route opening not reached within 3 sec. Control with FPC, adjust opening speed. Under „Status“, opening time + 400 ms.
18	VAK closed automatic		X	Adjust locking device. Make contact (NOC) of locking device is active with Automatic. Locking is set on „wrong“ position. Change operating mode on BDE-D to Locked and again to Automatic. Actuate manual unlocking, or rather completely reset it.
29	TOS not locked	TOS with DV		TOS not locked (rotary switches) on Locked. Turn rotary switches onto Locked position (above).
30	TOS locked	TOS with DV		Automatic mode, TOS locked, but door stays in manual mode.
31	EMERGENCY STOP			Emergency stop key has been pressed or manual unlocking has been actuated.
33	Error ELS1		X	Light barrier signal is not identified. Inform after-sales service. Calibrate ELS with 2 light pulses.
36	VOK closed I.		X	Locking device does not work properly. On BDE-D change operating mode to Automatic and again to Locked. Wrong locked position or VRR faulty.
37	Motor current		X	Possibly wrong motor type parameterised or motor is overloaded.
38	Motor 1 overheat		X	Motor 1 is too warm. Door works sluggishly.
39	Overload 24V		X	24 volts supply for peripheral units is overloaded. Check wiring.
41	Temp. sensor 1		X	With motor 1: temperature sensor is faulty or motor cable is disconnected.
42	Temp. sensor 2		X	With motor 2: temperature sensor is faulty or motor cable is disconnected.
43	Encoder fault		X	Encoder or cable is faulty or not plugged in. Reset.
44 W	T. motor high			Warning message; Time Delays will be extended. Door might work sluggishly. Check for presence of mechanical hindrance.
46	STG defective		X	Control unit is defective. Reset. If no success, then replace control unit.
47	SIO > 60 sec active		X	Door does not open or slides at reduced speed. Check Safety Sensor SIO.
48	NSK or SOK activated			Remote Alarm has just received. Control safety alarm. Control external signal.
50	Watchdog fault			Replace control unit.
51	VOK open unl.		X	Repeat locking and unlocking procedures. Connection cable might be missing or is not properly plugged in. Check locking settings.
52	No run param.		X	Door must be calibrated (perform teach-in run).
53	Interrupt. mot. 1		X	Motor is not plugged in. Motor is faulty.
54 W	Calibrating run		X	Warning message: Calibration run is performed.
55	Power failure			No mains supply. Door works in battery service provided that there is a battery and not "Basic escape route" has been configured.
57	Interrupt. mot. 2		X	2nd motor is not plugged in. Motor is faulty.
59	ELS > 60 sec. active			Light barriers interrupted or disconnected and door remains open. Check that safety barriers are not covered or extremely dirty.
59	SIS > 60 sec. active		X	Door does not close. Check Safety Sensor SIS.
60	EEPROM defective		X	Load factory settings. 9 light pulses with MFT and reset within 10 seconds. Afterwards language selection has to be displayed on BDE-D. Attention! All programmings are reset. Reconfigure door. Replace control unit if door still fails to function.
61	SSK > 60 sec. active			Key-operated contact stays active. Door remains open. Check Remote Switch (SSK) wiring, connections, and switch.
62	BDE no priority			BDE is locked e.g. by a clock timer on input SURV/SURA accordingly configured.
92	STG relay defect.		X	Change control unit.
93	Overvoltage 24V		X	Wiring error. Check connections.
96	EEPROM void		X	Load factory settings. See error 60.
97 W	Maintenance time exceeded		X	Warning message: Acknowledge message. Alarm is reset for 13 days. Actual value = 105% of target value of cycles or operating hours. Inform after-sales service and have installation serviced.
98 W	Maintenance due		X	Warning message: Acknowledge message. Alarm is reset for a short time. Repeats at 100% Actual value = 95% of target value of cycles or operating hours. Inform after-sales service and have installation serviced.
112	Batt. not charged complet.			Battery is not fully charged. Message disappears from display in case of full charge.

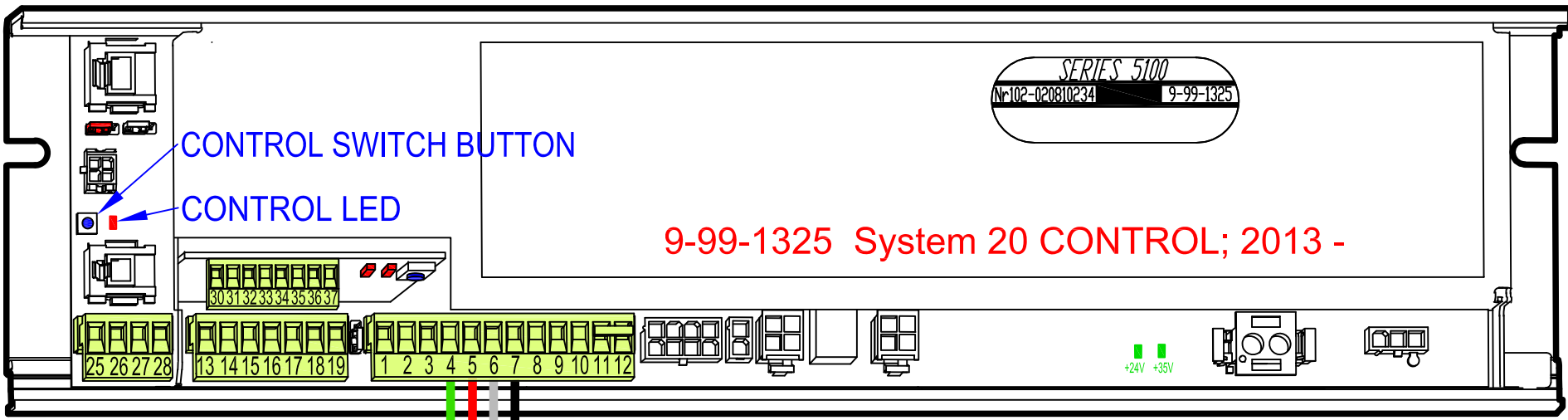

9-99-1325 System 20 CONTROL; 2013 -

TO CONNECT EITHER THE 4-51-0105 DUAL ROCKER SWITCH OR THE 4-51-0106 ROCKER / KEY SWITCH CONTROL PANEL TO THE 9-99-1325 SYSTEM 20 DOOR CONTROL ASSEMBLY, CONNECT THE TERMINAL AS SHOWN:

ROCKER CONTROL PANEL	DOOR CONTROL
15	5
16	4
17	6
18	7

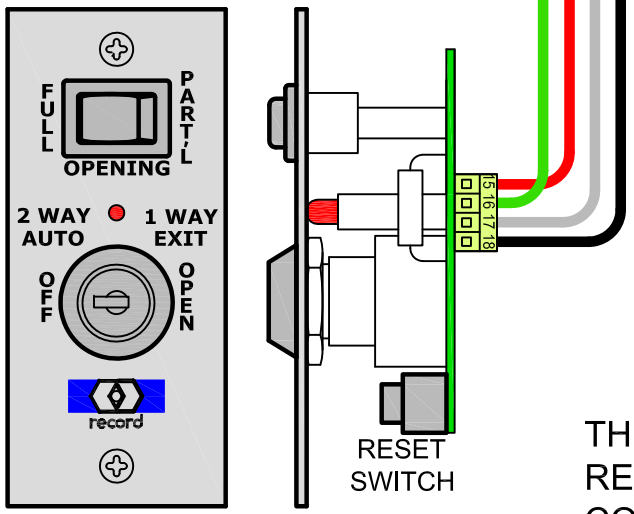

THE 9-99-1325 DOOR CONTROL ASSEMBLY MUST BE CONFIGURED TO RESPOND TO THE CONTROL PANEL. USING EITHER THE DISPLAY CONTROL PANEL OR THE FPC-902 FLASH PROGRAMMER, CHANGE THE

- FOLLOWING THREE PARAMETERS AS INDICATED:
 PARAMETER: CONTROL PANEL / MECHANICAL PANEL - CHANGE FROM "DISABLED" TO "ROCKER & KEYSW"
 PARAMETER: INPUT/OUTPUT / STG / AUX00_IN - CHANGE FROM "DISABLED" TO "BDEM_2"
 PARAMETER: INPUT/OUTPUT / STG / AUX01_IN - CHANGE FROM "DISABLED" TO "BDEM_1"

NOTE: WHEN USING BOTH A ROCKER SWITCH PANEL AND A DISPLAY CONTROL PANEL, THE ROCKER SWITCH PANEL WILL HAVE PRIORITY OVER THE DISPLAY PANEL IN ALL MODES EXCEPT "OFF". TO RESET THE DOOR WITH A ROCKER SWITCH PANEL, INSERT A PAPERCLIP IN THE SMALL HOLE IN THE CENTER OF THE LOGO, PRESS UNTIL A CLICK IS FELT AND HOLD FOR 15 SECONDS, THEN RELEASE.

CONTROL TERMINAL CONNECTIONS

- | | | |
|------------------------------|--------------------|-------------------------|
| 1 EMERGENCY STOP | 13 +24V POWER OUT | 30 SAFETY BEAM - XMTR1+ |
| 2 EMERGENCY STOP (+24V) | 14 INTERIOR SENSOR | 31 SAFETY BEAM - XMTR1- |
| 3 +24V POWER OUT | 15 0V POWER OUT | 32 SAFETY BEAM - RCVR1+ |
| 4 AUX00_IN | 16 EXTERIOR SENSOR | 33 SAFETY BEAM - RCVR1- |
| 5 +24V POWER OUT | 17 +24V POWER OUT | 34 SAFETY BEAM - XMTR2+ |
| 6 AUX01_IN | 18 AUX04_IN | 35 SAFETY BEAM - XMTR2- |
| 7 0V POWER OUT | 19 +24V | 36 SAFETY BEAM - RCVR2+ |
| 8 AUX0_OUT - NO | | 37 SAFETY BEAM - RCVR2- |
| 9 AUX0_OUT - COM | 25 CANBUS - DATAH | |
| 10 AUX0_OUT - NC | 26 CANBUS - DATAL | |
| 11 SPECIAL ACTIVATION (+24V) | 27 +24V | |
| 12 SPECIAL ACTIVATION | 28 0V | |



NOTE: FOR PROPER OPERATION, USE HARNESS PROVIDED WITH SENSORS TO BE INSTALLED. ALL WIRING SHOULD BE ROUTED AWAY FROM MOVING PARTS. POWER AVAILABLE FOR SENSORS: 24V, 1A.

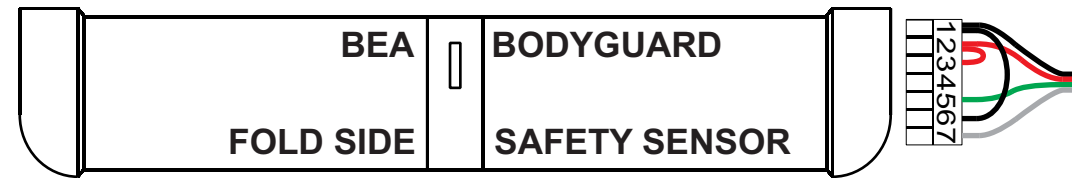

NOTE: FOR PROPER SAFETY SENSOR FUNCTION, PARAMETER "AUX04_IN" SHOULD BE SET TO "(35) SIA". FOR BODYGUARD DATALINE OPERATION, PARAMETER "AUX0_OUT" SHOULD BE SET TO "(18) OPEN". IF PRESENT, REMOVE JUMPER BETWEEN TERM. 18 & 19.

THIS PRODUCT IS INTENDED FOR PERMANENT CONNECTION TO THE ELECTRICAL SUPPLY SYSTEM

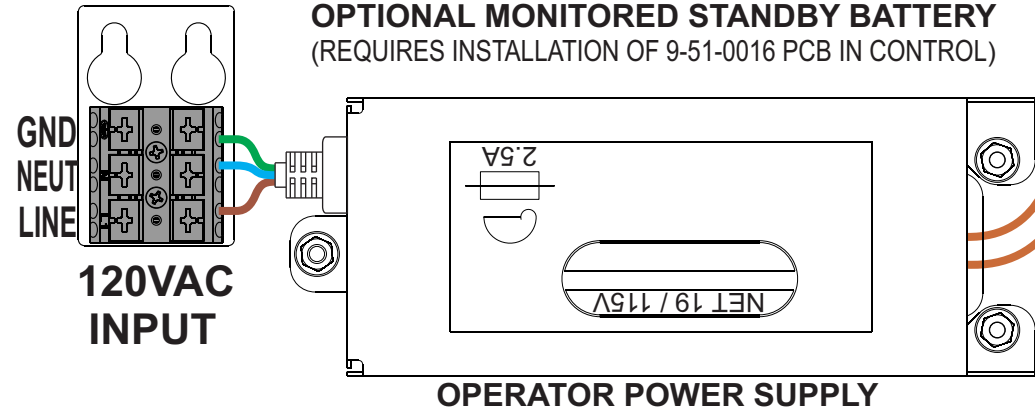

OPTIONAL MONITORED STANDBY BATTERY (REQUIRES INSTALLATION OF 9-51-0016 PCB IN CONTROL)

OPTIONAL BREAKOUT LOCK GRN & BRN-SOLENOID YEL & WHT-MON. SW.

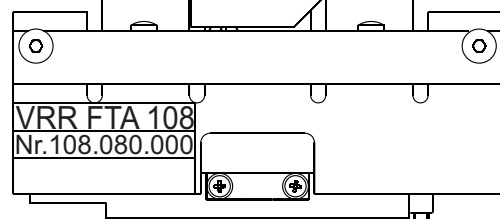
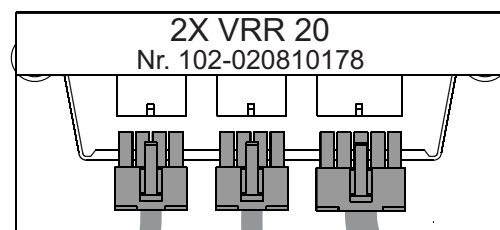

NOTE: FOR UNITS WITH BOTH FOLD & BREAKOUT ELECTRIC LOCKS, THE PARAMETER "LOCKING / LOCK TYPE" SHOULD BE SET TO "DOUBLE".

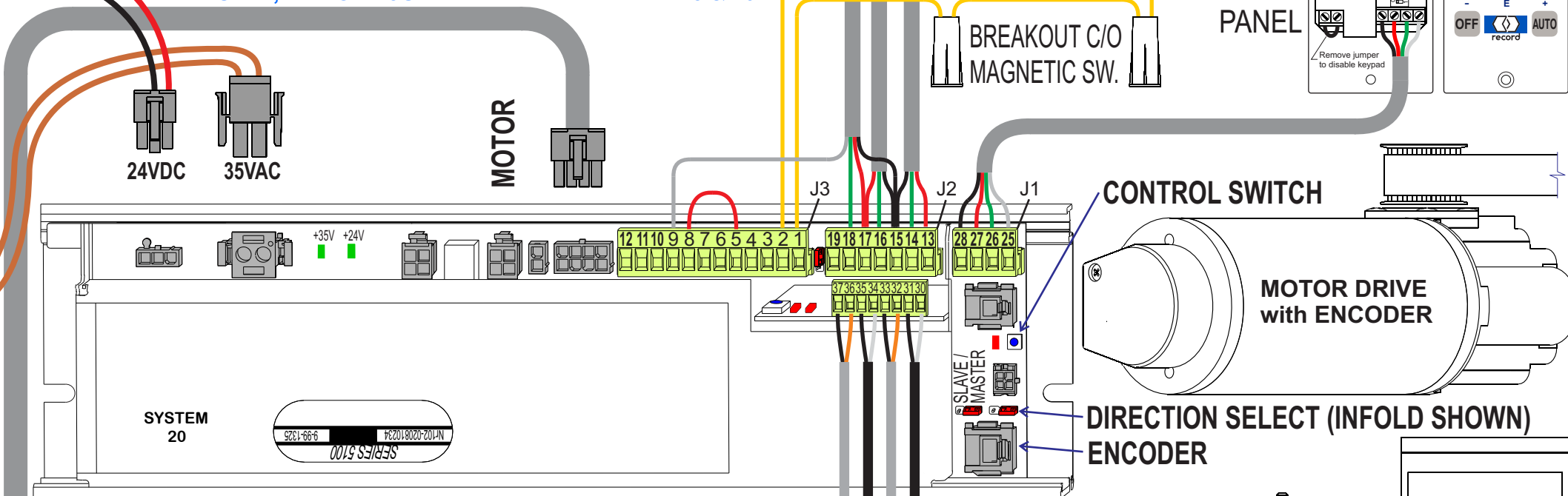

NOTE: SAFETY BEAMS CAN BE DISABLED WITH JUMPERS BETWEEN 31 & 32, AND 35 & 36.



OPTIONAL FOLD LOCK GRN & BRN-SOLENOID YEL & WHT-MON. SW.

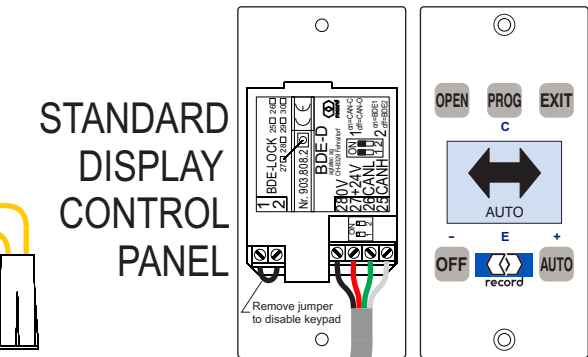

SERIES 4500 WIRING DIAGRAM with Sys20 CONTROL & BEA OVERHEAD SENSORS

JAN2013 DPH



CONTROL TERMINAL CONNECTIONS

- | | | |
|------------------------------|--------------------|-------------------------|
| 1 EMERGENCY STOP | 13 +24V POWER OUT | 30 SAFETY BEAM - XMTR1+ |
| 2 EMERGENCY STOP (+24V) | 14 INTERIOR SENSOR | 31 SAFETY BEAM - XMTR1- |
| 3 +24V POWER OUT | 15 0V POWER OUT | 32 SAFETY BEAM - RCVR1+ |
| 4 AUX00_IN | 16 EXTERIOR SENSOR | 33 SAFETY BEAM - RCVR1- |
| 5 +24V POWER OUT | 17 +24V POWER OUT | 34 SAFETY BEAM - XMTR2+ |
| 6 AUX01_IN | 18 AUX04_IN | 35 SAFETY BEAM - XMTR2- |
| 7 0V POWER OUT | 19 +24V | 36 SAFETY BEAM - RCVR2+ |
| 8 AUX0_OUT - NO | | 37 SAFETY BEAM - RCVR2- |
| 9 AUX0_OUT - COM | 25 CANBUS - DATAH | |
| 10 AUX0_OUT - NC | 26 CANBUS - DATAL | |
| 11 SPECIAL ACTIVATION (+24V) | 27 +24V | |
| 12 SPECIAL ACTIVATION | 28 0V | |

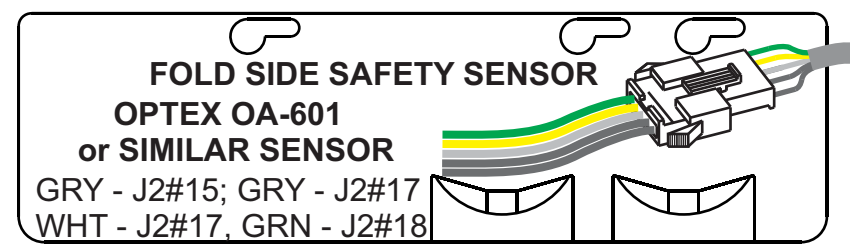

NOTE: FOR PROPER SAFETY SENSOR FUNCTION, PARAMETER "AUX4_IN" SHOULD BE SET TO "35-SIA" IF PRESENT, REMOVE JUMPER BETWEEN TERM. 18 & 19.

NOTE: FOR PROPER OPERATION, USE HARNESS PROVIDED WITH SENSORS TO BE INSTALLED. ALL WIRING SHOULD BE ROUTED AWAY FROM MOVING PARTS. POWER AVAILABLE FOR SENSORS: 24V, 1A.

THIS PRODUCT IS INTENDED FOR PERMANENT CONNECTION TO THE ELECTRICAL SUPPLY SYSTEM

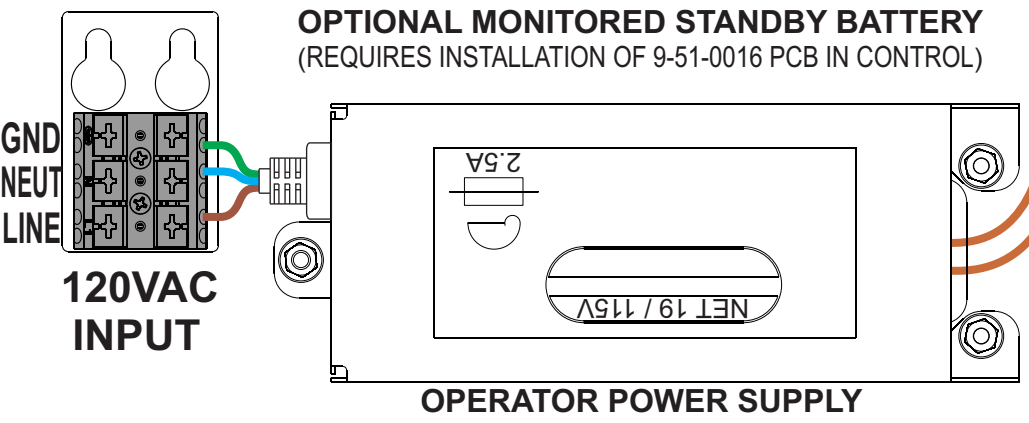

OPTIONAL BREAKOUT LOCK
GRN & BRN-SOLENOID
YEL & WHT-MON. SW.

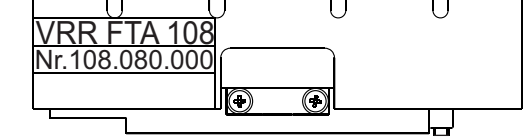
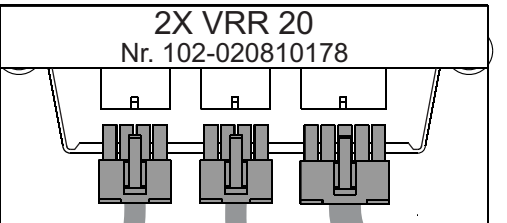

NOTE: FOR UNITS WITH BOTH FOLD & BREAKOUT ELECTRIC LOCKS, THE PARAMETER "LOCKING / LOCK TYPE" SHOULD BE SET TO "DOUBLE".

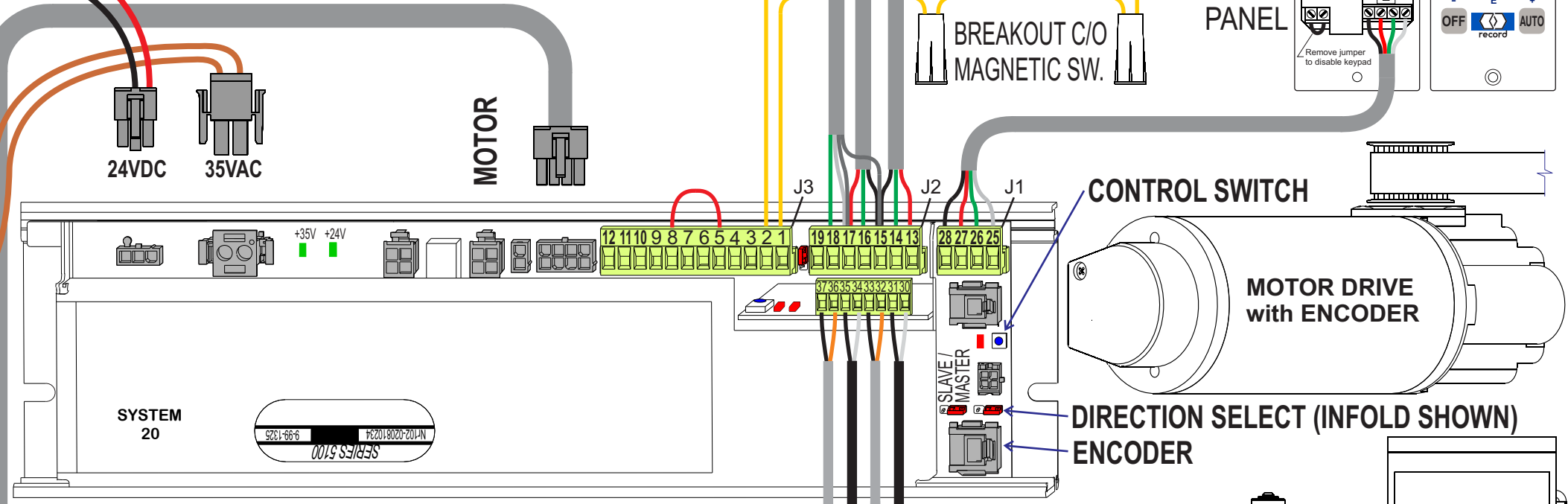

NOTE: SAFETY BEAMS CAN BE DISABLED WITH JUMPERS BETWEEN 31 & 32, AND 35 & 36.



OPTIONAL FOLD LOCK
GRN & BRN-SOLENOID
YEL & WHT-MON. SW.

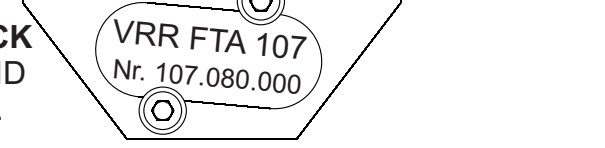

SERIES 4500 WIRING DIAGRAM with Sys20 CONTROL & OPEX OVERHEAD SENSORS

JAN2013 DPH



CONTROL TERMINAL CONNECTIONS

- | | | |
|------------------------------|--------------------|-------------------------|
| 1 EMERGENCY STOP | 13 +24V POWER OUT | 30 SAFETY BEAM - XMTR1+ |
| 2 EMERGENCY STOP (+24V) | 14 INTERIOR SENSOR | 31 SAFETY BEAM - XMTR1- |
| 3 +24V POWER OUT | 15 0V POWER OUT | 32 SAFETY BEAM - RCVR1+ |
| 4 AUX00_IN | 16 EXTERIOR SENSOR | 33 SAFETY BEAM - RCVR1- |
| 5 +24V POWER OUT | 17 +24V POWER OUT | 34 SAFETY BEAM - XMTR2+ |
| 6 AUX01_IN | 18 AUX04_IN | 35 SAFETY BEAM - XMTR2- |
| 7 0V POWER OUT | 19 +24V | 36 SAFETY BEAM - RCVR2+ |
| 8 AUX0_OUT - NO | | 37 SAFETY BEAM - RCVR2- |
| 9 AUX0_OUT - COM | 25 CANBUS - DATAH | |
| 10 AUX0_OUT - NC | 26 CANBUS - DATAL | |
| 11 SPECIAL ACTIVATION (+24V) | 27 +24V | |
| 12 SPECIAL ACTIVATION | 28 0V | |

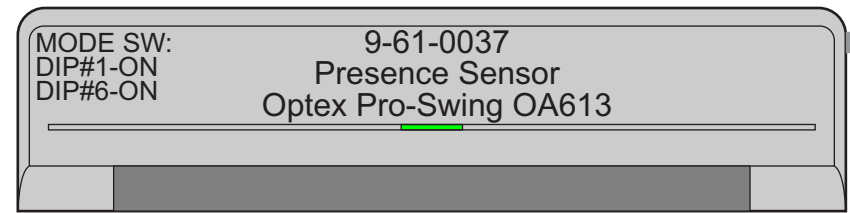
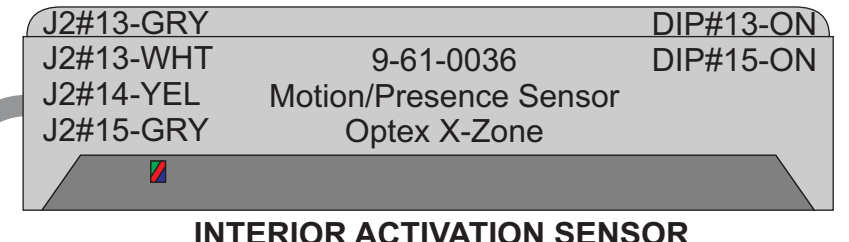
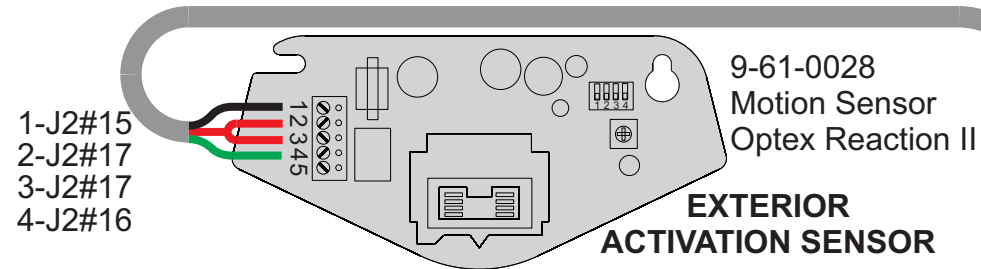

FOLD SIDE SAFETY SENSOR
 FOR PROPER OPERATION, USE HARNESSSES PROVIDED WITH SENSORS TO BE INSTALLED. ALL WIRING SHOULD BE ROUTED AWAY FROM MOVING PARTS. MAX. SENSOR LOAD: 1AMP @ 24V.

NOTE: FOR PROPER SAFETY SENSOR FUNCTION, SET PARAMETER "AUX4_IN" TO "35-SIA", AND "AUX0_OUT" TO "OPEN"; REMOVE JUMPER BETWEEN TERM. 18 & 19.

THIS PRODUCT IS INTENDED FOR PERMANENT CONNECTION TO THE ELECTRICAL SUPPLY SYSTEM

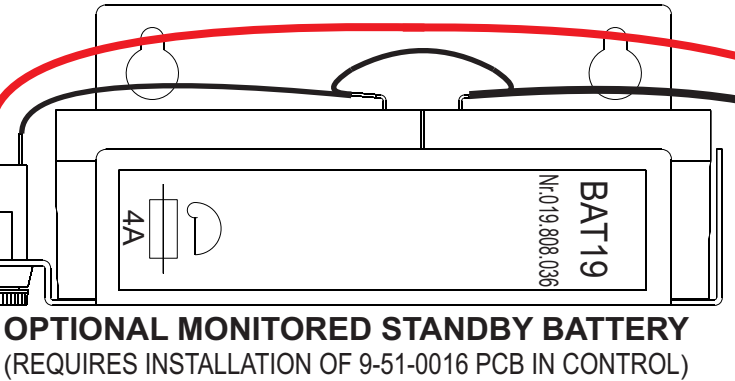
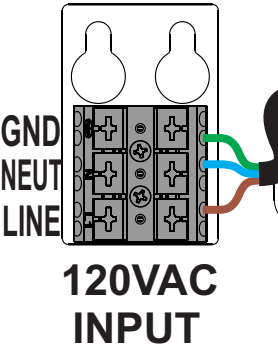

OPTIONAL MONITORED STANDBY BATTERY
 (REQUIRES INSTALLATION OF 9-51-0016 PCB IN CONTROL)

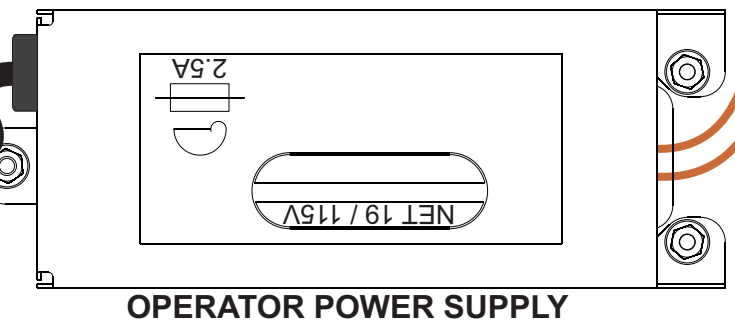

OPERATOR POWER SUPPLY

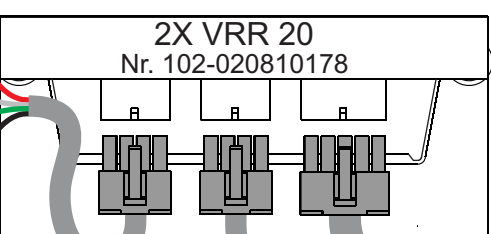
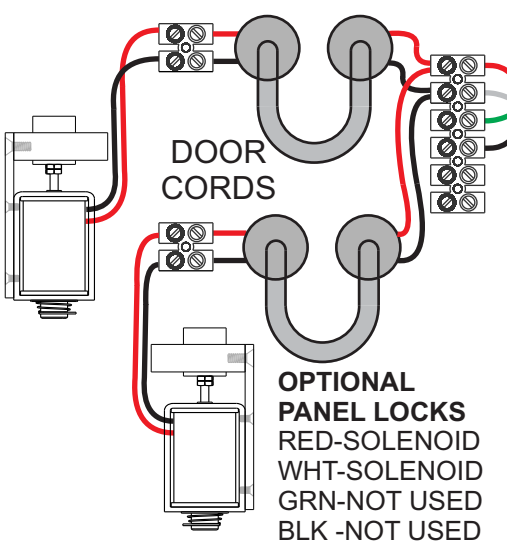

NOTE: DIP SWITCH SETTINGS: S1-ON,OFF,OFF,OFF; S2-OFF,OFF,ON,OFF FOR UNITS WITH BOTH PANEL AND BREAKOUT ELECTRIC LOCKS, THE PARAMETER "LOCKING / LOCK TYPE" SHOULD BE SET TO "DOUBLE".

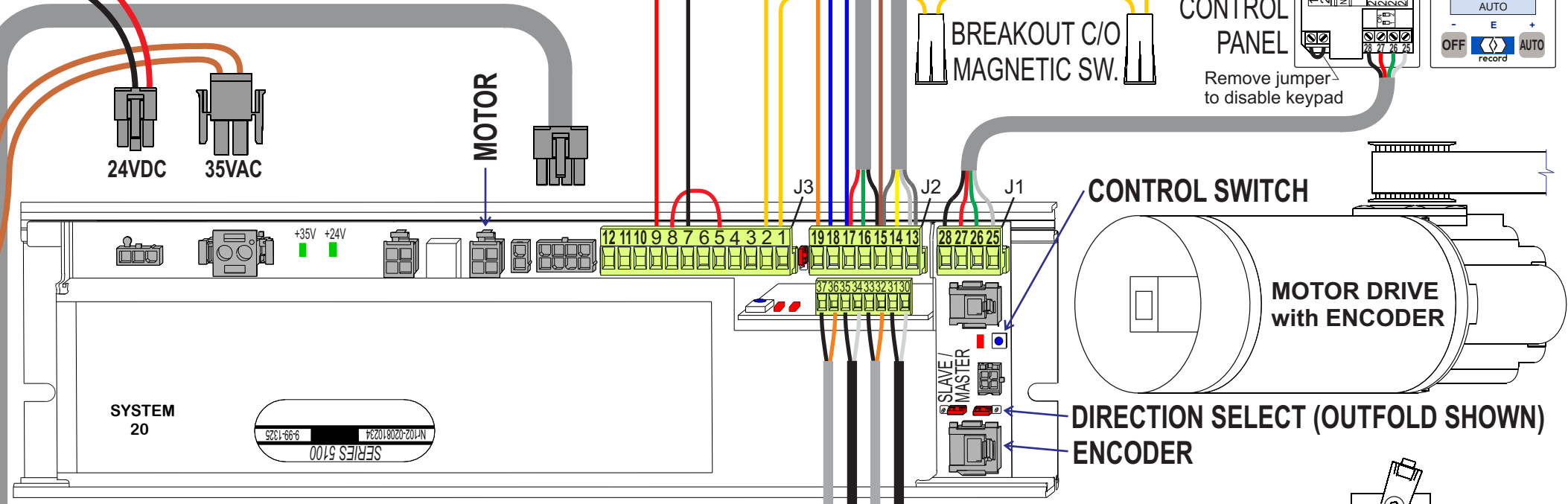

NOTE: SAFETY BEAMS CAN BE DISABLED WITH JUMPERS BETWEEN 31 & 32, AND 35 & 36.



OPTIONAL BREAKOUT LOCK
 GRN & BRN-SOLENOID
 YEL & WHT-MON. SW.

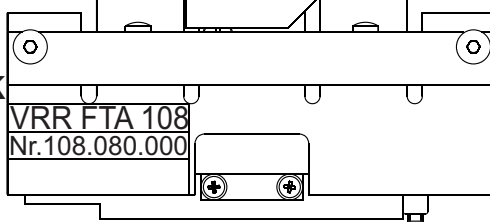

SERIES 4500 WIRING DIAGRAM with Sys20 CONTROL & OPTEX SENSOR PACKAGE III

JUN2013 DPH

